

# Protein Blotting Guide



A Guide to Transfer and Detection  
**Third Edition**

**BIO-RAD**

# About This Manual

This reference manual provides information on the fundamentals of protein transfer and detection chemistries. It is also a guide to the methods, equipment, and reagents used in protein blotting experiments, and offers troubleshooting tips and technical advice.

As a researcher using the blotting technique, you know that each research objective, experimental approach, and protein sample can be different. Your equipment, sample, antibody, and detection chemistries all can impact your results. The goal of this manual is to provide you with a broad understanding of the variables you face when blotting, and how best to work with each of them to achieve the optimal results.

## A History of Leadership and Quality

A pioneer in the design and manufacture of western blotting apparatus with 30 years of experience, Bio-Rad is considered the industry leader in providing high-quality, durable, and powerful blotting equipment.

Bio-Rad offers superior products and expert technical service. Our goal is to support your research with the necessary tools and materials to optimize the analysis of complex protein samples.

## Meeting Your Blotting Needs

Turn to Bio-Rad for:

- Gel-blotting equipment for an array of gel sizes
- Microfiltration devices
- Multiple-sample screening devices
- Membranes for every binding requirement
- Protein standards
- Blotting buffers, reagents, and background removal kits
- Colorimetric and chemiluminescent detection reagents
- Total protein stains
- Secondary antibodies and antibody conjugates

For detailed protocols on the use of any of the products mentioned in this guide, please refer to their instruction manuals, available in Adobe Acrobat (PDF) format at [discover.bio-rad.com](http://discover.bio-rad.com)

<b>Introduction to Protein Blotting</b> . . . . .	<b>7</b>	<b>Power Conditions for Electrophoretic Transfers</b> . . . . .	<b>21</b>
<b>Chapter 1 Transfer</b>		Useful Equations . . . . .	22
<b>Transfer Methods</b> . . . . .	<b>9</b>	Joule Heating . . . . .	22
Electrophoretic Transfer		Other Factors Affecting Transfer . . . . .	22
The Principle of Electrophoretic Transfer		Relationship Between Power Settings and	
Types of Electrophoretic Transfer		Transfer Times . . . . .	22
Microfiltration (Dot-Blotting) . . . . .	11	High-Intensity Field Transfers	
<b>Blotting Systems and Power Supplies</b> . . . . .	<b>12</b>	Standard Field Transfers	
Transfer Apparatus . . . . .	12	Selecting Power Supply Settings . . . . .	22
Tank Blotting Apparatus		Transfers Under Constant Voltage	
Semi-Dry Blotting Apparatus		Transfers Under Constant Current	
Microfiltration Apparatus		Transfers Under Constant Power	
Power Supplies for Electrophoretic Transfers . . . . .	15	<b>General Guidelines for Transfer Buffers</b>	
<b>Chapter 2 Membranes, Buffers, and</b>		<b>and Transfer Conditions</b> . . . . .	<b>24</b>
<b>Power Conditions</b>		<b>Chapter 3 Performing the Transfer</b>	
<b>Membrane Selection</b> . . . . .	<b>17</b>	<b>Electrophoretic Transfer</b> . . . . .	<b>25</b>
Nitrocellulose and Supported Nitrocellulose . . . . .	17	<b>Performing a Tank Transfer</b> . . . . .	<b>25</b>
Polyvinylidene Difluoride (PVDF) Membrane . . . . .	18	Preparing the Transfer Buffer, Gels, and	
<b>Blotting Filter Paper</b> . . . . .	<b>18</b>	Tank Assembly . . . . .	25
<b>Membrane/Filter Paper Sandwiches</b> . . . . .	<b>19</b>	Assembling the Gel and Membrane Sandwich . . . . .	26
<b>Transfer Buffer Selection</b> . . . . .	<b>19</b>	Performing the Transfer . . . . .	27
General Recommendations . . . . .	20	<b>Performing a Semi-Dry Transfer</b> . . . . .	<b>27</b>
A Note About SDS and Alcohol		Preparing the Transfer Buffer and Gels . . . . .	27
Towbin and Bjerrum and Schafer-Nielsen Buffers		Assembling the Gel and Membrane Sandwich . . . . .	28
(Tris/Glycine Buffers) . . . . .	20	Performing the Transfer . . . . .	28
CAPS Buffer . . . . .	21	<b>Microfiltration</b> . . . . .	<b>29</b>
Discontinuous Tris-CAPS Buffer System		Application of the Vacuum . . . . .	28
(Semi-Dry Transfers) . . . . .	21	Proper Drainage . . . . .	29
Dunn Carbonate Buffer . . . . .	21	Flow Valve — Extended Incubations . . . . .	29
Alternative Buffer Conditions . . . . .	21	Flow Valve — Gentle Vacuum . . . . .	29
		Filtering or Centrifugation of Samples . . . . .	29
		Air Bubbles . . . . .	29
		Membrane Removal . . . . .	29

## Chapter 4 Detection

<b>Detection Methods</b> .....	<b>31</b>
<b>Protein Standards</b> .....	<b>32</b>
Prestained Standards for Western Blotting .....	33
Recombinant Prestained Standards	
Natural Prestained SDS-PAGE Standards	
Unstained Standards for Western Blotting .....	35
<b>Total Protein Staining</b> .....	<b>36</b>
Anionic Dyes .....	37
Colloidal Gold .....	37
Biotinylation .....	38
Fluorescence .....	38
<b>Immunological Detection Systems</b> .....	<b>38</b>
Blocking Reagents .....	39
Antibody Incubations .....	39
Primary Antibodies	
Species-Specific Secondary Antibodies	
Antibody-Specific Ligands	
Washes .....	41
Detection Methods .....	41
Colorimetric Detection	
Chemiluminescent Detection	
Other Detection Methods	
Imaging — Documentation and Analysis Methods ..	48
Luminescent Detection	
Fluorescent, Chemifluorescent, and Colorimetric Detection	
Autoradiography	
Screening Apparatus .....	50

## Chapter 5 Troubleshooting

<b>Transfer</b> .....	<b>52</b>
Electrophoretic Transfer .....	52
Poor Electrophoretic Transfer	
Swirls or Missing Patterns; Diffuse Transfers	

Gel Cassette Pattern Transferred to Blot	
Poor Binding to the Membrane — Nitrocellulose	
Poor Binding to the Membrane — PVDF	
Blotting Standards .....	55
Missing Bands	
Molecular Weight Assignments for Natural (Nonrecombinant) Prestained Standards Differ From Lot to Lot	
A Protein's Molecular Weight Differs From Expected Molecular Weight	
Variation in Mobility Between Recombinant and Natural Prestained Standards of the Same Molecular Weight	
Microfiltration Blotting .....	56
Leakage or Cross-Well Contamination	
Uneven Filtration or No Filtration	
Halos Around the Wells	
<b>Detection</b> .....	<b>57</b>
Immunological Detection .....	57
Overall High Background	
Nonspecific Reactions Between Bound Proteins and Probes	
No Reaction or Weak Signal	
Tests for Monitoring Reagent Activity	
Multiscreen Apparatus .....	59
Leakage or Cross-Well Contamination	
Bubbles Trapped Within the Channels	
Halos Around the Wells	
Total Protein Detection .....	59
Colloidal Gold Total Protein Stain — High Background	
Colloidal Gold Total Protein Stain — Low Sensitivity	
Biotin-Blot™ Total Protein Detection — High Background	
Biotin-Blot Total Protein Detection — No Reaction or Weak Color Development	
Anionic Dyes — High Background	
Anionic Dyes — Low Sensitivity	

## Appendices

---

<b>Transfer Buffer Formulations</b> .....	<b>.62</b>
<b>Detection Buffer Formulations</b> .....	<b>.63</b>
General Detection Buffers .....	.63
Total Protein Staining Buffers and Solutions .....	.64
Substrate Buffers and Solutions .....	.64
<b>Assay Procedures</b> .....	<b>.66</b>
Immun-Blot® Assay .....	.66
Total Protein Detection Procedures .....	.67
<b>Glossary</b> .....	<b>.68</b>
<b>References</b> .....	<b>.72</b>
<b>Trademarks and Legal Notices</b> .....	<b>.73</b>
<b>Ordering Information</b> .....	<b>.74</b>

**Overview of protein blotting methods.** Dark colors indicate the transfer phase, light colors indicate the detection phase.

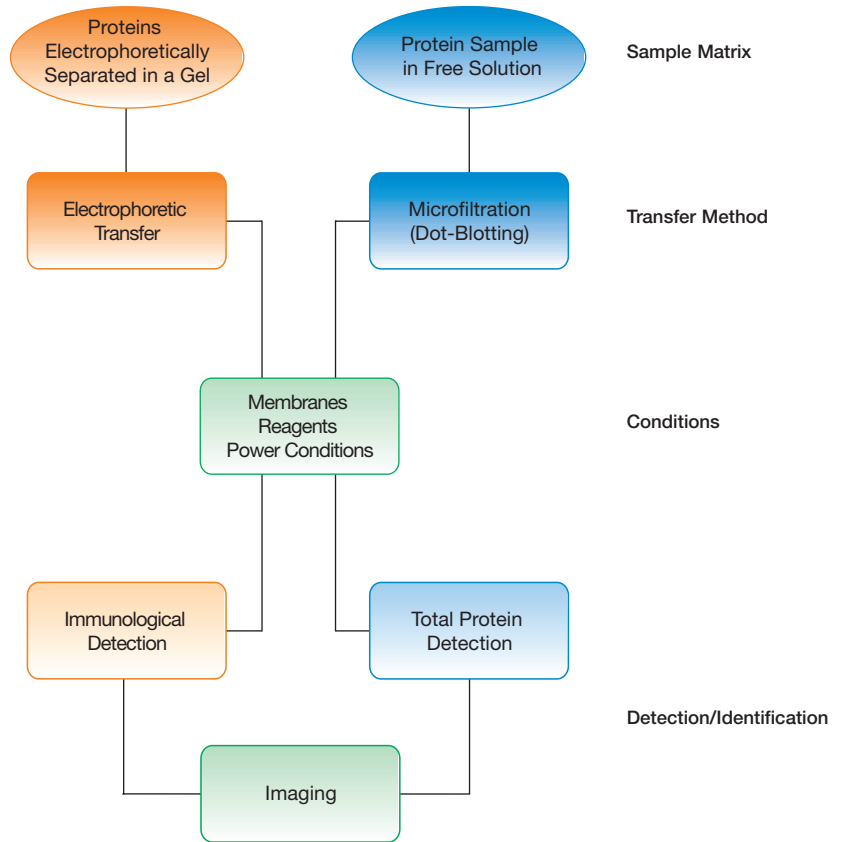

# Introduction to Protein Blotting

Protein blotting, the transfer of proteins to solid-phase membrane supports, has become a powerful and popular technique for the visualization and identification of proteins. When bound to membranes, proteins are readily accessible for immunological or biochemical analyses, quantitative staining, or demonstration of protein-protein or protein-ligand interactions.

Protein blotting involves two major phases: transfer and detection (see overview opposite).

## Transfer

The transfer step involves moving the proteins from a solution or gel and immobilizing them on a synthetic membrane support (blot). Transfer may be performed by direct application or dot-blotting of proteins that are in solution, or by electrophoretic transfer of proteins from a gel to a membrane. In performing a protein transfer, the researcher must choose the appropriate method, apparatus, membrane, buffer, and transfer conditions.

## Detection

Detection entails probing the membrane with either a total protein stain or primary antibodies specific to the protein(s) of interest and subsequent visualization of the labeled proteins. Detection involves a number of steps and the selection of the appropriate method, reagents, and imaging equipment.

The most commonly used protein blotting technique, western blotting (immunoblotting), was developed as a result of the need to probe for proteins that were inaccessible to antibodies while in polyacrylamide gels. Western blotting procedures involve the transfer of proteins that have been separated by gel electrophoresis onto a membrane, followed by immunological detection of these proteins. Western blotting combines the resolution of gel electrophoresis with the specificity of immunoassays, allowing individual proteins in mixtures to be identified and analyzed. Since the development of immunoblotting techniques, other probing and detection techniques have been developed for functional protein characterization.

Many applications and methods for protein blotting have been previously reviewed (Beisiegel 1986, Bers and Garfin 1985, Carr and Scott 1992, Crisp and Dunn 1994, Dunn 1994, 1999, Egger and Bienz 1994, Garfin and Bers 1989, Gershoni 1985, 1987, 1988, Gershoni and Palade 1983, Gooderham 1984, Harper, et al. 1990, Kurien and Scofield 2003, Tovey and Baldo 1987, Wisdom 1994). This manual summarizes the most commonly used techniques, provides information about the wide selection of blotting apparatus and detection reagents available from Bio-Rad, and offers troubleshooting tips and technical advice.





# Transfer

The initial step in any blotting experiment is the transfer of proteins from a solution or gel and immobilization of those proteins on a solid membrane support. Immobilization of proteins on a membrane makes the proteins accessible to probes for specific proteins and enables quantitative detection.

This chapter reviews the options that are available for blotting instruments and power supplies. Chapter 2 describes the various membranes, transfer buffers, and power conditions that may be used for transfer. Chapter 3 provides an overview of the steps and workflow involved in performing protein transfer. Subsequent processing of the protein blots for detection and identification is discussed in Chapter 4.

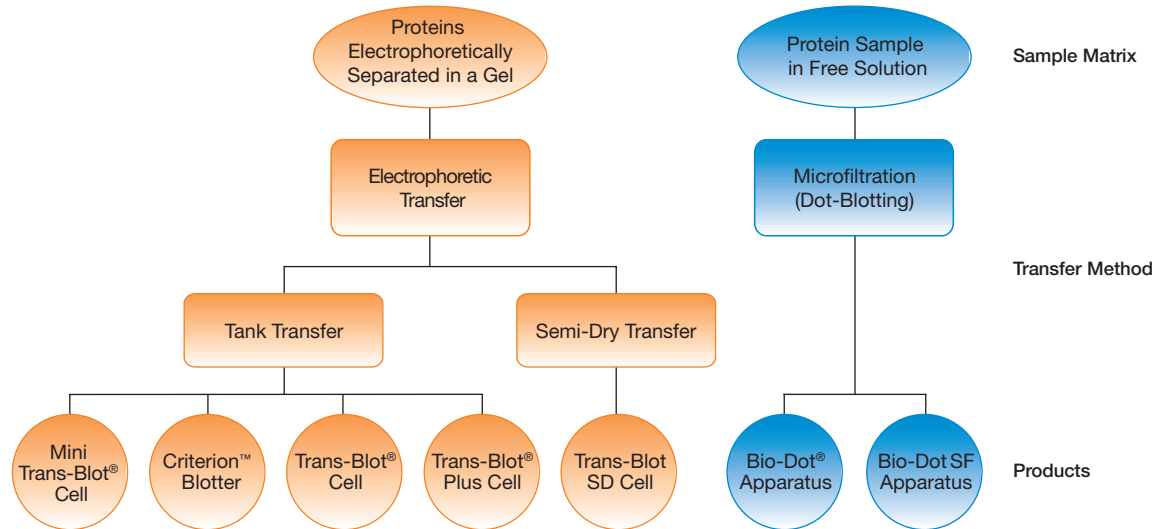

**Fig. 1.1. Protein transfer systems.**

## Transfer Methods

Proteins can be transferred to membranes by a number of methods. The most common are electrophoretic transfer and microfiltration (dot-blotting). Although diffusion or capillary blotting methods may also be used to transfer proteins from gels, generally electrophoretic transfer is used to transfer proteins following electrophoretic separation by SDS-polyacrylamide gel electrophoresis (SDS-PAGE) or by native PAGE — whereas microfiltration is used to transfer proteins that are in solution (Figure 1.1). Electrophoretic transfer of proteins is fast, efficient, and preserves the high-resolution separation of proteins by PAGE. Microfiltration is particularly useful to determine working conditions for a new blotting assay or in any other situation where the resolving power of gel electrophoresis is not needed.

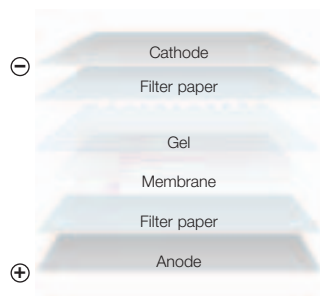

**Fig. 1.2. Gel and membrane setup for electrophoretic transfer.**

## Electrophoretic Transfer

Electrophoretic methods are used to elute proteins from gels and transfer them to membranes. Electrophoretic transfer is the most widely used blotting method because of its speed and precision in replicating the pattern of separated proteins from a gel to a membrane.

### The Principle of Electrophoretic Transfer

In an electrophoretic transfer, the membrane and protein-containing gel are placed together with filter paper between two electrodes (Figure 1.2). Proteins migrate to the membrane following a current ( $I$ ) that is generated by applying a voltage ( $V$ ) across the electrodes, following Ohm's law:

$$V = I \times R$$

where  $R$  is the resistance generated by the materials placed between the electrodes (that is, the transfer buffer, gel, membrane, and filter papers).

The electric field strength ( $V/cm$ ) that is generated between the electrodes is the driving force for electrophoretic transfer. Though a number of other factors, including the size, shape, and charge of the protein and the pH, viscosity, and ionic strength of the transfer buffer and gel %T may influence the elution of particular proteins from gels, both the applied voltage and the distance

between the electrodes play a major role in governing the rate of elution of the proteins from the gel. There are practical limits on field strength, however, due to the production of heat during transfer.

The heat generated during a transfer (Joule heating) is proportional to the power consumed by the electrical elements ( $P$ ), which is equal to the product of the current ( $I$ ) and voltage ( $V$ ).

$$P = I \times V = I^2 \times R$$

Joule heating increases temperature and decreases resistance of the transfer buffer. Such changes in resistance may lead to inconsistent field strength and transfer, or may cause the transfer buffer to lose its buffering capacity. In addition, excessive heat may cause the gel to deteriorate and stick to the membrane. The major limitation of any electrophoretic transfer method is the ability of the chamber to dissipate heat.

### Types of Electrophoretic Transfer

There are two main types of electrophoretic blotting apparatus and transfer procedures: tank, or wet transfer, where gels and membranes are submerged under transfer buffer in tanks, and semi-dry transfer, where gels and membranes are sandwiched between buffer-wetted filter papers that are in direct contact with flat-plate electrodes. The two types of transfer systems are compared in Table 1.1.

**Table 1.1. Comparison of electrophoretic protein transfer systems.**

	Tank Blotting	Semi-Dry Blotting
Flexibility	Flexible voltage settings, blotting times, and cooling requirements; flexible electrode positions (Trans-Blot and Trans-Blot Plus cells)	Dedicated to rapid transfer with minimal transfer buffer, without cooling
Quantitative vs. qualitative results	Quantitative transfer of low molecular weight proteins possible under conditions that allow efficient binding to the membrane	Some low molecular weight molecules will be transferred through the membrane without binding quantitatively
Molecular weight range	Broad molecular weight range	Variable transfer efficiencies for proteins >120 kD (may be improved with discontinuous buffer system); low molecular weight proteins may be transferred through membrane
Transfer time	Extended transfer (up to 24 hr) possible without buffer depletion; rapid transfers (15–60 min) obtained under high-intensity conditions	Rapid transfers; extended transfers not possible due to buffer depletion
Temperature control	Specific temperature regulation with cooling coil and refrigerated water recirculator; permits transfers at low temperatures (4–10°C), for example, native enzyme transfers	Temperature regulation by external cooling is not possible
Buffer capacity	Up to 10–12 L (Trans-Blot Plus cell) or as little as 450 ml (Mini Trans-Blot cell); length of blotting time not restricted by limited buffer capacity	Minimal, ~250 ml per experiment; reduced cost of reagents and experiment time

### Tank Blotting

In tank transfer systems, the gel and membrane sandwich is entirely submerged under transfer buffer within a buffer tank. A nonconducting cassette holds the membrane in close contact with the gel and the cassette assembly is placed in the tank between the electrodes, transverse to the electrical field, and submerged under conducting transfer buffer (Burnette 1981, Gershoni et al. 1985, Towbin et al. 1979). Although large volumes of buffer in the tank dissipate the heat generated during transfer and provide the conducting capacity for extended transfer conditions, additional cooling mechanisms are offered by the various tank blotter systems.

Tank transfer systems contain the following elements:

- **Buffer tank and lid** — The buffer tank and lid combine to fully enclose the inner chamber during electrophoresis. On the inside, the tank has slots for placement of the electrode cards, gel holder cassettes, and the cooling element. Ports on the lid allow connection points for the electrodes
- **Gel holder cassette** — The gel and membrane sandwich is held together between two fiber pads and filter paper sheets and placed into the tank within a gel holder cassette. Cassettes are made of nonconducting material and are designed to permit unimpeded flow of current and buffer through the gel and membrane sandwich
- **Electrodes** — Tank transfer systems use either plate or wire electrode cards. Plate electrodes offer greater field strength than wire electrodes, but wire electrodes may be more economical and generate less heat
- **Cooling mechanism** — Cooling systems consist of an in ice block, a sealed ice unit, or a cooling coil that is coupled to an external cooling mechanism. These cooling systems prevent temperature fluctuations and overheating during high-intensity, extended, or native protein transfers

Tank transfer systems are recommended for most routine protein work, for efficient and quantitative protein transfers, and for transfers of proteins of all sizes.

### Semi-Dry Blotting

In a semi-dry transfer, the gel and membrane are sandwiched between two stacks of filter paper and are in direct contact with plate electrodes (Bjerrum and Schafer-Nielsen 1986, Kyhse-Andersen 1984, Tovey and Baldo 1987). The term “semi-dry” refers to the limited amount of buffer, which is confined to the two stacks of filter paper.

In semi-dry systems, the distance between the electrodes is limited only by the thickness of the gel/membrane sandwich. As a result, high electric field strengths and high-intensity blotting conditions are achieved. Under semi-dry conditions, some small proteins may be driven through the membrane in response to the high field strengths. Moreover, because low buffer capacity limits run times, some large proteins may be poorly transferred. Use of a discontinuous buffer system (see Chapter 2) may enhance semi-dry transfer of high molecular weight proteins (>80 kD). As semi-dry transfers require considerably less buffer and are easier to set up than the tank method, laboratories performing large numbers of blots often favor them.

### Microfiltration (Dot-Blotting)

Simple, bulk transfer of proteins that are in solution may be achieved by manual application (dotting) to a membrane from a pipet or syringe, or by vacuum-assisted microfiltration. Manual dot-blotting with a pipet or syringe is generally used for small sample volumes. Microfiltration devices, on the other hand, enable application of larger volumes, multiple assays with different probes, and quick, reproducible screening of a large number of samples.

Microfiltration facilitates the determination of working conditions for a new blotting assay and is a convenient method in any other situation where the resolving power of gel electrophoresis is not needed.

## Blotting Systems and Power Supplies

### Transfer Apparatus

The transfer of proteins to a membrane support is accomplished by electrophoresis (tank or semi-dry blotting) for gels and by microfiltration (dot-blotting) for proteins in solution.

### Tank Blotting Apparatus

Tank transfer systems offer flexibility in choosing voltage settings, blotting times, and cooling options. Tank transfer systems provide efficient and quantitative protein transfers over a broad molecular weight range. The tank transfer systems offered by Bio-Rad are described below, and their specifications are summarized in Table 1.2.

#### Trans-Blot Cell

The Trans-Blot cell (Figure 1.3) offers a choice of plate or wire electrodes and variable placement of the electrodes for

both standard and high-intensity blotting options. The Trans-Blot cell accommodates three gel holder cassettes, each with a 16 x 20 cm blotting area. Standard field transfers are performed with the electrodes placed 8 cm apart; with this arrangement, all three of the gel holder cassettes may be used simultaneously. High-intensity transfers are performed with the electrodes placed 4 cm apart, with a single gel holder cassette between them. Temperature regulation can be achieved by using the super cooling coil (included) and a refrigerated water recirculator (purchased separately).

#### Trans-Blot Plus Cell

The Trans-Blot Plus cell (Figure 1.4) is designed to provide efficient transfers of protein from large format (28 x 26.5 cm) gels. The Trans-Blot Plus has the capacity to transfer three large format gels or multiple smaller format gels simultaneously in as little as 15–30 min. Each gel holder cassette is constructed of a durable material that, along with an effective clamping mechanism, ensures tight, uniform contact between the gel and membrane across the entire blotting area. A detachable hinge mechanism in the cassette virtually eliminates shifting of gel sandwiches during assembly. Plate electrodes provide a strong and uniform electrical field and are movable — one, two, or three gel cassettes can be placed in the

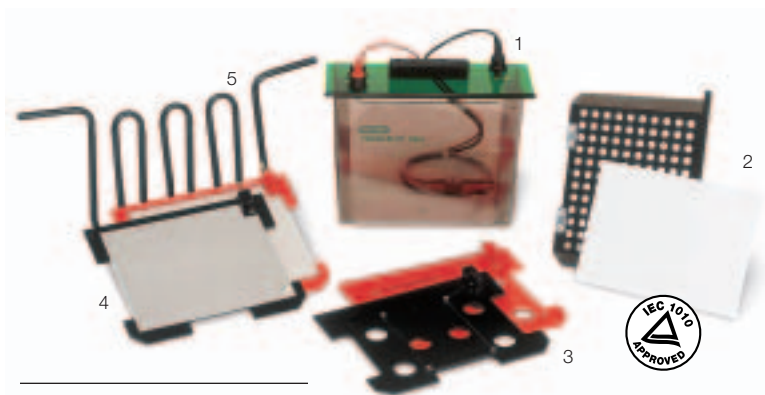

**Fig. 1.3. The Trans-Blot cell.** 1, buffer tank and lid; 2, gel holder cassette and fiber pads; 3, wire electrodes; 4, plate electrodes; 5, super cooling coil.

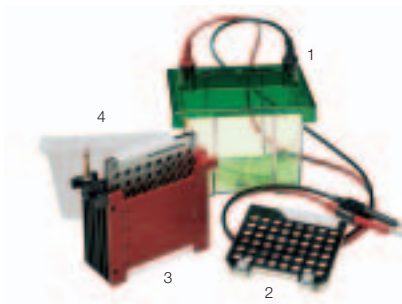

**Fig. 1.4. The Trans-Blot Plus cell.** 1, buffer tank and lid; 2, gel holder cassette and fiber pads; 3, plate electrodes; 4, super cooling coil.

tank with the minimum electrode distance between them, increasing the field strength and efficiency of transfer. A cooling coil coupled to a refrigerated water recirculator provides effective temperature regulation, ensuring effective and reproducible transfers even during high-intensity, high-power applications.

### Mini Trans-Blot Cell and Criterion Blotter

The Mini Trans-Blot cell and the Criterion blotter accommodate smaller gels for rapid, high-quality blotting. The Mini Trans-Blot cell (Figure 1.5) can transfer up to two mini gels (10 x 7.5 cm) in an hour and is available either as a complete apparatus, or as a module that uses the buffer tank and lid of the Mini-PROTEAN® 3 cell for operation. The Criterion blotter (Figure 1.6) can transfer up to two Criterion gels (15 x 9.4 cm) or four mini gels in 30–60 min. A self-contained Bio-Ice cooling unit absorbs the heat generated during transfer in the Mini Trans-Blot cell, and the Criterion blotter uses a sealed ice block or optional cooling coil to regulate temperature during transfer.



**Fig. 1.5. The Mini Trans-Blot cell.** 1, buffer tank and lid; 2, gel holder cassette; 3, electrode assembly; 4, Bio-Ice™ cooling unit.

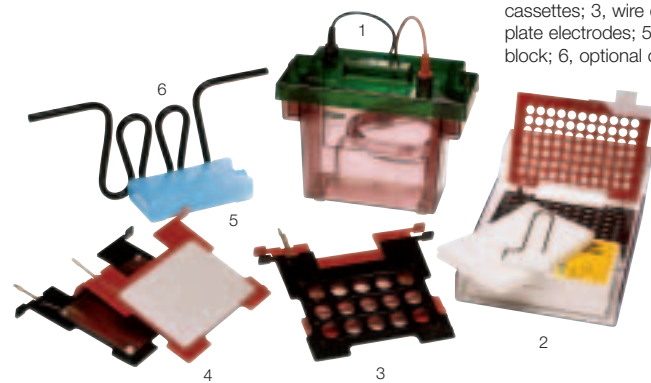

**Fig. 1.6. The Criterion blotter.** 1, buffer tank and lid; 2, assembly tray with roller, fiber pads, blotting filter paper, and gel holder cassettes; 3, wire electrodes; 4, plate electrodes; 5, sealed ice block; 6, optional cooling coil.

**Table 1.2. Specifications for tank blotting cells.**

	Trans-Blot	Trans-Blot Plus	Mini Trans-Blot	Criterion Blotter
Blotting area	Standard: 16 x 20 cm	Extra large: 28 x 26.5 cm	Mini: 10 x 7.5 cm	Midi: 15 x 9.4 cm
Number of cassettes	1 for high-intensity transfer, 2 with cooling, 3 without cooling	3	2	2
Buffer requirements	2.5 L	10–12 L	450 ml	1.3 L
Electrode distance	Flexible; 2 positions: 4 and 8 cm	Flexible; 3 positions: 4, 7, and 10 cm	4 cm	4.3 cm
Electrode materials	Platinum-coated titanium anode and stainless-steel cathode plates or platinum wire	Platinum-coated titanium anode and stainless-steel cathode plates	Platinum wire	Platinum-coated titanium anode and stainless-steel cathode plates or platinum wire
Transfer time	Standard: 2–5 hr (wire electrodes), 1–2 hr (plate electrodes) High-intensity: 1–2 hr (wire electrodes), 0.5–1 hr plate electrodes	Standard: 16 hr (overnight) High-intensity: 0.25–1 hr	1 hr	0.5–1 hr (wire electrodes) 0.5 hr (plate electrodes)
Cooling	Super cooling coil	Super cooling coil	Bio-Ice cooling unit	Sealed ice block or optional Criterion blotter cooling coil
Dimensions (W x L x H)	18 x 9.5 x 24 cm	30 x 17.3 x 39.4 cm	12 x 16 x 18 cm	21.8 x 11.8 x 15 cm



**Fig. 1.7. The Trans-Blot SD cell.** 1, lid; 2, cathode plate; 3, anode plate.

### Semi-Dry Blotting Apparatus

Semi-dry transfers allow fast, efficient, economical blotting without a buffer tank or gel cassettes.

#### Trans-Blot SD Semi-Dry Cell

The Trans-Blot SD semi-dry cell (Figure 1.7) performs high-intensity electrophoretic transfers quickly and efficiently without requiring external cooling. Most mini gel transfers are accomplished in less than 30 minutes. Plate electrodes and a unique single-step locking system designed for the Trans-Blot SD cell make assembly easy and ensure uniform contact across the entire electrode surface. See Table 1.3 for detailed specifications.

**Table 1.3. Trans-Blot SD semi-dry cell specifications.**

Maximum gel size (W x L)	24 x 16 cm
Gel capacity	Two PROTEAN® II gel sandwiches, stacked and separated by dialysis membrane; four Mini-PROTEAN 3 gels side by side; three Criterion gels side by side
Buffer requirement	~200 ml
Electrode dimensions	25 x 18 cm
Electrode distance	Determined by thickness of the gel sandwich and filter paper stack
Electrode materials	Platinum-coated titanium anode and stainless-steel cathode
Cooling	N/A
Dimensions (W x L x H)	37 x 24 x 11 cm

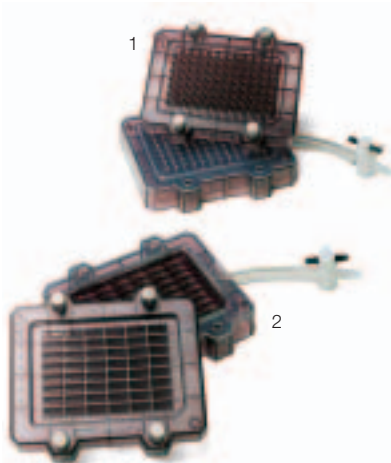

**Fig. 1.8. Microfiltration apparatus.** 1, Bio-Dot microfiltration unit; 2, Bio-Dot SF microfiltration unit.

### Microfiltration Apparatus

Microfiltration units allow use of easy, reproducible methods for binding proteins in solution onto membranes.

#### Bio-Dot® and Bio-Dot SF Apparatus

The Bio-Dot and the Bio-Dot SF (slot-format) microfiltration units (Figure 1.8) provide reproducible binding of proteins in solution onto membranes. Samples are loaded into the wells of the templates and proteins are trapped on the membrane by filtration using either vacuum or gravity flow. Once samples are loaded, incubations, wash steps, and detection may all be performed without removing the membrane from the unit.

The 96-well Bio-Dot apparatus performs traditional dot-blot comparisons while the 48-well Bio-Dot SF apparatus focuses the applied samples into thin lines instead of circles (Figure 1.9). This slot format makes it easier to use a densitometer for quantitation. The Bio-Dot and Bio-Dot SF sample templates are interchangeable; each uses the same microfiltration manifold. Each apparatus is available as an independent unit, containing both the microfiltration manifold and the sample template, and also as a modular template without the manifold base.

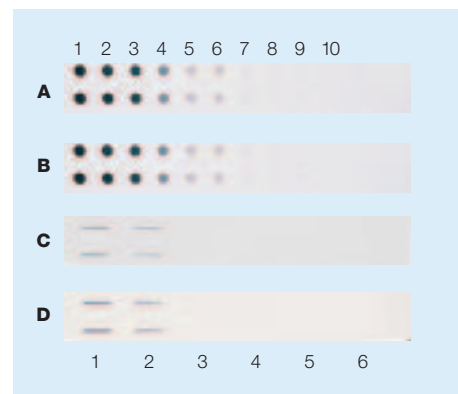

**Fig. 1.9. Multiple sample comparisons are simplified with the Bio-Dot and Bio-Dot SF microfiltration units.** A and B, antigen (human transferrin) applied to nitrocellulose in each row of the Bio-Dot apparatus. 1, 100 ng; 2, 50 ng; 3, 25 ng; 4, 10 ng; 5, 5 ng; 6, 2.5 ng; 7, 1 ng; 8, 0.5 ng; 9, 0.25 ng; 10, 1% BSA in TBS. C and D, antigen applied to each row of the Bio-Dot SF apparatus. 1, 100 ng; 2, 50 ng; 3, 10 ng; 4, 5 ng; 5, 1 ng; 6, 0.1 ng. The membranes were incubated with rabbit anti-human transferrin. In A and C, Bio-Rad's goat anti-rabbit gold conjugate and gold enhancement kit were used to visualize the antigen. In B and D, Bio-Rad's goat anti-rabbit AP conjugate and the color development reagents BCIP and NBT were used to visualize the antigen.

The Bio-Dot and Bio-Dot SF units may be easily sterilized by autoclaving or by washing in alcohol or sodium hydroxide (NaOH). The units feature a unique, patented sealing gasket that eliminates lateral leakage and possible cross-contamination between wells. Both sample templates are spaced similarly to microplates so that samples can be applied with a standard or multichannel pipet. Specifications for the Bio-Dot units are listed in Table 1.4.

**Table 1.4. Bio-Dot apparatus specifications.**

	Bio-Dot	Bio-Dot SF
Sample format	96-well, 8 x 12 format	48-slot, 6 x 8 format
Well size	3 mm diameter	7 x 0.75 mm
Sample volume	50–600 $\mu$ l	50–500 $\mu$ l
Membrane size (W x L)	9 x 12 cm	9 x 12 cm
Autoclavability	Yes	Yes

## Power Supplies for Electrophoretic Transfers

Electrophoretic transfer cells require high currents that not all power supplies are equipped to deliver. Table 1.5 compares the two Bio-Rad power supplies (Figure 1.10) that accommodate the needs of electrophoretic transfer systems.

### PowerPac™ HC Power Supply

The PowerPac HC (high current) power supply, with a 250 V, 3.0 A, 300 W output, is capable of driving all transfer cells to their maximum performance. The PowerPac HC has replaced the 200 V, 2.0 A PowerPac™ 200 power supply and offers high power output and the flexibility of choosing transfer under constant voltage, constant current, or constant power settings. The PowerPac HC also offers highly regulated voltage settings, fine adjustment of current limits, and a convenient pause function. Safety features include overload/short circuit detection, automatic crossover, arc and ground leak detection, programmable multistep methods, and a programmable timer.

### PowerPac™ Universal Power Supply

The PowerPac Universal power supply is for researchers demanding a power supply capable of performing the broadest range of applications possible. With 500 V, 2.5 A, 500 W output, the PowerPac Universal is designed to drive all of the most common electrophoretic applications, with the exception of high-voltage applications such as isoelectric focusing and DNA sequencing. Like the PowerPac HC, the PowerPac Universal provides the choice of transfer under constant voltage, constant current, or constant power settings with all of the other features listed above. In addition, the PowerPac Universal stores up to nine methods, each with up to nine steps, and is equipped to enable wireless transfer of run data and protocols for instrument validation for regulatory purposes (for example, installation qualification and operational qualification, or IQ/OQ).

**Table 1.5. PowerPac HC and PowerPac Universal power supply specifications.**

	PowerPac HC	PowerPac Universal
Voltage	5–250 V	5–500 V
Current	0.01–3.0 A	0.01–2.5 A
Power	1–300 W	1–500 W



**Fig. 1.10. Power supplies.** PowerPac HC (top) and PowerPac Universal (bottom) power supplies.





# Membranes, Buffers, and Power Conditions

Selecting the appropriate membrane, transfer buffer, and power conditions is critical to successful protein transfer. The size and charge of the proteins, the transfer method, and the binding properties of the membrane must all be considered. This chapter provides technical information and advice for selecting among the various conditions that are available for protein transfer. Subsequent processing of the transferred proteins for detection and identification is discussed in Chapter 4.

## Membrane Selection

Though nitrocellulose was once the only choice for protein blotting, advances in membrane chemistries have made a variety of membrane types available, each offering key attributes to suit particular experimental conditions. The physical properties and performance characteristics of a membrane should be evaluated when selecting the appropriate transfer conditions (Table 2.1).

Membranes are commonly available in two pore sizes: the 0.45  $\mu\text{m}$  pore size membranes are recommended for most analytical blotting experiments, while the 0.2  $\mu\text{m}$  pore size membranes are most suitable for transfer of low molecular weight (<15,000) proteins that might move through larger membrane pores.

### Nitrocellulose and Supported Nitrocellulose

Nitrocellulose was one of the first membranes used for western blotting and is still a popular membrane for this procedure. Protein binding to nitrocellulose is instantaneous, nearly irreversible, and quantitative up to 80 to 100  $\mu\text{g}/\text{cm}^2$ . Nitrocellulose is easily wetted in water or transfer buffer and is compatible with a wide range of protein detection systems.

Supported nitrocellulose is an inert support structure with nitrocellulose applied to it. The support structure gives the membrane increased strength and resilience. Supported nitrocellulose can withstand reprobing and autoclaving (121  $^{\circ}\text{C}$ ) and retains the ease of wetting and protein binding features of nitrocellulose.

**Table 2.1. Guide to protein blotting membranes.**

Membrane	Pore Size	Binding Capacity ( $\mu\text{g}/\text{cm}^2$ )	Notes
Nitrocellulose	0.45 $\mu\text{m}$ 0.2 $\mu\text{m}$	80–100	General-purpose protein blotting membrane
Supported nitrocellulose	0.45 $\mu\text{m}$ 0.2 $\mu\text{m}$	80–100	Pure nitrocellulose cast on an inert synthetic support; increased strength for easier handling and for reprobing
Sequi-Blot PVDF	0.2 $\mu\text{m}$	170–200	High mechanical strength and chemical stability; used for protein sequencing
Immun-Blot PVDF	0.2 $\mu\text{m}$	150–160	High mechanical strength and chemical stability; recommended for western blotting

## Polyvinylidene Difluoride (PVDF) Membrane

PVDF membrane is an ideal support for N-terminal sequencing, amino acid analysis, and immunoassay of blotted proteins. PVDF retains proteins during exposure to acidic or basic conditions and in the presence of organic solvents. Greater protein retention during sequencing manipulations enhances the likelihood of obtaining information from rare, low-abundance proteins by increased initial coupling and higher repetitive yields. In addition, PVDF membrane exhibits better binding efficiency of electroblotted material in the presence of SDS in the transfer buffer. PVDF membrane must be wetted in 100% methanol prior to use but may be used with a transfer buffer that contains no methanol.

Bio-Rad offers PVDF membrane specifically designed for protein sequencing and for immunodetection. Both are available in precut sheets, rolls, and sandwich formats.

### Sequi-Blot™ PVDF for Protein Sequencing

Originally named Bio-Rad PVDF membrane, Sequi-Blot PVDF membrane withstands the conditions of N-terminal sequencing while providing the binding capacity to sequence even low-abundance samples. See Figure 2.1.

### Immun-Blot® PVDF for Western Blotting

Immun-Blot PVDF membrane is ideal for chemiluminescent and colorimetric western blots because it retains target protein but resists nonspecific protein binding that can obscure high-sensitivity detection. Immun-Blot PVDF has a strong binding capacity of 150–160  $\mu\text{g}/\text{cm}^2$  (roughly twice that of nitrocellulose), will not crack or tear in common handling, and holds up under repeated stripping and reprobing.

**Fig. 2.1. Superior retention of proteins by Bio-Rad's Sequi-Blot PVDF membrane.**

Protein samples were blotted to PVDF membrane support (diagrammed on left) using Towbin buffer containing 0.1% SDS. Membrane A, the membrane sheet closest to the gel; membrane B, a second sheet of membrane layered behind the first.

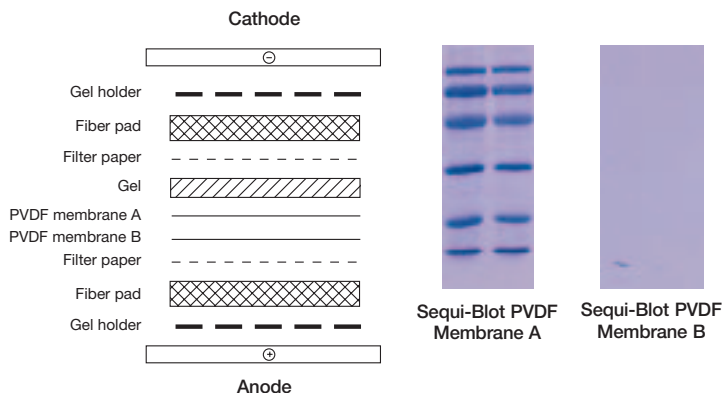

## Blotting Filter Paper

Blotting filter paper, made of 100% cotton fiber, provides a uniform flow of buffer through the gel. This paper contains no additives that might interfere with the transfer process. Precut filter paper is

available in a wide range of convenient sizes to eliminate waste and save time (Table 2.2). Extra thick absorbent filter paper is recommended for semi-dry transfers because of its additional fluid capacity.

**Table 2.2. Guide to precut membranes and filter paper.**

Electrophoretic Blotting Apparatus	Precut Membranes	Precut Blot Filter Papers
Trans-Blot® cell	13.5 x 16.5 cm	15 x 20 cm
Trans-Blot® Plus cell	26.5 x 28 cm	26.5 x 28 cm
Trans-Blot SD cell	7 x 8.4 cm 11.5 x 16 cm 15 x 15 cm 15 x 9.2 cm 20 x 20 cm	15 x 15 cm (extra thick)
Mini Trans-Blot® cell	7 x 8.4 cm	7.5 x 10 cm
Criterion™ blotter	8.5 x 13.5 cm	9.5 x 15.2 cm
Bio-Dot® apparatus	9 x 12 cm	N/A
Bio-Dot SF apparatus	9 x 12 cm	11.3 x 7.7 cm

## Membrane/Filter Paper Sandwiches

Precut and preassembled sandwiches save time and effort during western blot preparation. In Bio-Rad's membrane sandwiches, a precut membrane

(nitrocellulose or PVDF) and two sheets of 100% cotton fiber thick filter paper are preassembled into a blotting membrane/filter paper sandwich.

## Transfer Buffer Selection

Different gel types and blotting applications call for different transfer buffers (Tables 2.3 and 2.4), but in general, transfer buffer must enable both effective elution of proteins from the gel matrix and binding of the protein to the membrane. The choice of buffer will depend on the type of gel and membrane being used as well as the physical characteristics of the protein of interest.

Transfer buffers contain a conductive, strong buffering agent (for example, Tris, CAPS, or carbonate) in order to maintain the conductivity and pH of the system during transfer. In addition, alcohol (for example, methanol or ethanol) may be included in the transfer buffer to promote binding of proteins to membranes, and SDS may be added to promote elution of proteins from gels.

**Table 2.3. General guidelines on transfer buffer and membrane selection by gel type.**

Gel Type	Transfer Buffer	Membrane	Notes
SDS-PAGE	Towbin, with or without SDS, CAPS, carbonate, Bjerrum Schafer-Nielsen	Nitrocellulose or supported nitrocellulose, 0.45 or 0.2 $\mu\text{m}$ , or PVDF	Tank blotting or semi-dry blotting
Tris-Tricine SDS-PAGE	Towbin, CAPS	Nitrocellulose or supported nitrocellulose, 0.2 $\mu\text{m}$ , or PVDF	Tank blotting recommended; needs high-capacity, small-pore-size membrane; pH of buffer may be critical
Two-dimensional gel	Towbin, with or without SDS, CAPS, carbonate, Bjerrum Schafer-Nielsen	Nitrocellulose or supported nitrocellulose, 0.45 or 0.2 $\mu\text{m}$ , or PVDF	Tank blotting or semi-dry blotting
Native, nondenaturing	Depends on pH of gel buffer and pI of protein of interest	Nitrocellulose, 0.45 or 0.2 $\mu\text{m}$ , or PVDF	Specific temperature regulation may be needed to maintain activity
Acid urea	0.7% acetic acid	Nitrocellulose, 0.45 or 0.2 $\mu\text{m}$	Use acid-gel transfer protocol (membrane toward cathode)
Isoelectric focusing gel	0.7% acetic acid	Nitrocellulose or supported nitrocellulose, 0.45 or 0.2 $\mu\text{m}$ , or PVDF	Use acid-gel transfer protocol (membrane toward cathode)

**Table 2.4. General guidelines on transfer buffer and membrane selection by application.**

Special Applications	Transfer Buffer	Membrane	Notes
Protein sequencing	Towbin,* CAPS	Nitrocellulose, 0.45 or 0.2 $\mu\text{m}$ , or PVDF	Tank blotting recommended
High molecular weight proteins	Towbin with SDS	Nitrocellulose, 0.45 or 0.2 $\mu\text{m}$ , or PVDF	Tank blotting recommended; needs high-capacity, small-pore-size membrane; pH of buffer may be critical
Small proteins and peptides	Towbin, CAPS	Nitrocellulose, 0.2 $\mu\text{m}$ , or PVDF	Tank blotting recommended; pH of buffer may be critical
Basic proteins (pI >9) run in denaturing gels	CAPS, carbonate, Bjerrum Schafer-Nielsen	Nitrocellulose, 0.45 or 0.2 $\mu\text{m}$ , or PVDF	Tank blotting or semi-dry blotting
Basic proteins (pI >9) run in native or nondenaturing gels	0.7% acetic acid	Nitrocellulose, 0.45 or 0.2 $\mu\text{m}$ , or PVDF	Tank blotting recommended
Glycoproteins	Towbin, with or without SDS, CAPS, carbonate, Bjerrum Schafer-Nielsen	Nitrocellulose, 0.45 or 0.2 $\mu\text{m}$ , or PVDF	Tank blotting or semi-dry blotting
Proteoglycans	Towbin, Bjerrum Schafer-Nielsen	Nitrocellulose, 0.45 or 0.2 $\mu\text{m}$ , or PVDF	Tank blotting or semi-dry blotting

\* Towbin buffer may be used for protein sequencing but extra care must be exercised to rinse Tris and glycine from the membrane after transfer.

### General Recommendations

Regardless of which transfer buffer is selected, transfer buffer should never be used more than once, since the buffer will likely lose its capacity to maintain a stable pH during transfer. Similarly, diluting transfer buffers is not advised, since this will decrease their buffering capacity. Lastly, adjusting the pH of transfer buffers when not indicated will result in increased buffer conductivity, manifested by higher initial current output and decreased resistance.

Recipes for all of the buffers described in this section are provided in the Appendix.

#### A Note About SDS and Alcohol

SDS and alcohol play opposing roles in a transfer.

SDS in the gel and in the SDS-protein complexes promotes elution of the protein from the gel but inhibits binding of the protein to membranes. In cases where certain proteins are difficult to elute from the gel, SDS may be added to the transfer buffer to improve transfer. SDS in the transfer buffer decreases the binding efficiency of protein to nitrocellulose membrane; PVDF membrane can be substituted for nitrocellulose when SDS is used in the transfer buffer. Addition of SDS will increase the relative current, power, and heating during transfer, and may also affect the antigenicity of some proteins.

Alcohol (methanol or ethanol), on the other hand, removes the SDS from SDS-protein complexes and improves the binding of protein to nitrocellulose membrane, but has some negative effects on the gel itself. Alcohol may cause a reduction in pore size, precipitation of some proteins, and some basic proteins to become positively charged or neutral. All of these factors will affect blotting efficiency.

**Note:** Only high-quality, analytical grade methanol should be used in transfer buffer; impure methanol can cause increased transfer buffer conductivity and poor transfer.

#### Towbin and Bjerrum and Schafer-Nielsen Buffers (Tris/Glycine Buffers)

The most common transfers are from SDS-PAGE gels using the buffer systems originally described by Towbin (1979). Standard Towbin buffer contains 25 mM Tris, pH 8.3, 192 mM glycine, 20% (v/v) methanol and, occasionally, 0.025–0.1% (w/v) SDS. A buffer similar in composition to the standard Towbin buffer is the Bjerrum and Schafer-Nielsen buffer (48 mM Tris, pH 9.2, 39 mM glycine, 20% methanol), which was developed for use in semi-dry applications.

### CAPS Buffer

CAPS-based transfer buffers (10 mM CAPS, pH 11, 10% methanol) may be preferable for transfers of high molecular weight proteins (for example, >50 kD) and in cases where the glycine component of Towbin buffer may interfere with downstream protein sequencing applications.

### Discontinuous Tris-CAPS Buffer System (Semi-Dry Transfers)

A unique feature of semi-dry blotting is the ability to use two different buffers during transfer, known as a discontinuous buffer system. This is possible because in a semi-dry transfer, the buffer reservoirs are the filter paper on either side of the gel, which are independent. In a discontinuous system, methanol is included in the buffer on the membrane (anode) side of the blot assembly and SDS is used on the gel (cathode) side, taking advantage of the positive effects of each buffer component.

A discontinuous buffer system using a Tris-CAPS buffer can greatly increase the efficiency of protein transfer by semi-dry blotting. This system uses 60 mM Tris, 40 mM CAPS, pH 9.6, plus 15% methanol in the filter paper on the anode side and 0.1% SDS on the cathode side. Concentrated, premixed anode and cathode buffers are available for purchase. For more information about the use of a discontinuous buffer system in semi-dry transfer, request bulletin 2134.

### Dunn Carbonate Buffer

In some cases, using a carbonate buffer (10 mM NaHCO<sub>3</sub>, 3 mM Na<sub>2</sub>CO<sub>3</sub>, pH 9.9, 20% methanol) may produce higher efficiency transfers and improve the ability of antibodies to recognize and bind to proteins. Carbonate buffer has also been recommended for the transfer of basic proteins (Garfin and Bers 1989).

### Alternative Buffer Conditions

The mobility of proteins during electrophoretic transfer from native gels will depend on the size and pI of the protein of interest relative to the pH of the buffer used.

- If the pI of the protein is greater than the pH of the transfer buffer, the protein will carry a positive charge and will migrate toward the negative electrode
- If the pI of the protein is close to the pH of the transfer buffer, the migration of the protein out of the gel will be decreased. A more basic or acidic buffer should be used to increase protein mobility

Proteins in native gels as well as acidic and neutral proteins require buffers that do not contain methanol. Gels for isoelectric focusing, native PAGE, and those containing basic proteins or acid-urea may be transferred in 0.7% acetic acid. When using acetic acid for transfer, the proteins will be positively charged, so the membrane should be placed on the cathode side of the gel.

## Power Conditions for Electrophoretic Transfers

The optimal condition for electrophoretic transfer is to run at the highest electric field strength (V/cm) possible within the heat dissipation capabilities of the system; that is, for most proteins, the most rapid transfer occurs under conditions where the applied voltage (V) is maximized and the distance

between the electrodes is minimized. Though rapid blotting experiments may seem most convenient, a number of factors must be considered when choosing the appropriate power conditions for a given electrophoretic transfer.

## Useful Equations

Two basic electrical equations are important in electrophoresis. The first is Ohm's law, which relates the applied voltage (V), with the current (I) and resistance (R) of the system:

$$V = I \times R$$

The applied voltage and current are determined by the user and the power supply settings; the resistance is inherent in the system.

The second equation, the power equation, describes the power (P) used by a system, which is proportional to the voltage (V), current (I), and resistance of the system (R).

$$P = I \times V = I^2 \times R = V^2/R$$

Understanding the relationships between power, voltage, current, resistance, and heat is central to understanding the factors that influence the efficiency and efficacy of transfer.

## Joule Heating

The power that is dissipated is also equivalent to the amount of heat, known as Joule heating, generated by the system. According to the power equation, the amount of Joule heating that occurs depends on the conductivity of the transfer buffer used, the magnitude of the applied field, and the total resistance within the transfer system.

During the course of an electrophoretic transfer, the transfer buffer is warmed as a result of Joule heating. Consequently, its resistance drops. Such heating and changes in resistance may lead to inconsistent field strength and transfer, may cause the transfer buffer to lose its buffering capacity, or may cause the gel to melt and stick to the membrane.

Under normal running conditions, the transfer buffer absorbs most of the heat that is generated. During extended transfer periods or high-power conditions, active buffer cooling is required to prevent uncontrolled temperature increases.

## Other Factors Affecting Transfer

The following variables will also change resistance of the transfer system and will, therefore, also affect transfer efficiency and current and voltage readings:

- Alterations to buffer makeup; that is, addition of SDS or changes in ion concentration due to addition of acid or base to adjust the pH of a buffer
- Gel pH, ionic strength, and percentage of acrylamide, especially if the gel has not been properly equilibrated
- Number of gels (current increases slightly as the number of gels increases)
- Volume of buffer (current increases when volume increases)
- Transfer temperature (current increases when temperature increases)

## Relationship Between Power Settings and Transfer Times

In theory, increasing the power input and duration of an electrophoretic transfer results in the transfer of more protein out of a gel. However, in practice, initial test runs should be used to evaluate transfer efficiency at various field strengths (by modulating both power input and, if applicable, interelectrode distance) and transfer times for each set of proteins of interest. The optimum transfer conditions will actually vary according to a number of factors, including the size, charge, and electrophoretic mobility of the protein, the type of transfer buffer used, and the type of transfer system being used.

## High-Intensity Field Transfers

As their name suggests, high-intensity field transfers use high-strength electrical fields that are generated by increased voltage and closer positioning of electrodes. High-intensity transfers generally require less than 5 hr to complete. Though high-intensity transfers often produce satisfactory transfer

of proteins in less time, in some cases the high electric field strength may cause small proteins to be transferred too quickly and through the membrane. In addition, high molecular weight proteins, and other proteins that are difficult to transfer, may not have sufficient time to be transferred completely. Since more heat is generated in high-intensity filed transfers than in standard field transfers, a cooling device may be needed.

### Standard Field Transfers

These transfers require less power input and more time to complete; they are generally run overnight. Standard transfers often produce more complete, quantitative transfer of proteins across a broad molecular weight range; the slower transfer conditions allow large proteins sufficient time to move through the gel matrix while the lower intensity allows smaller proteins to remain attached to the membrane after transfer.

Tank transfer systems offer the capacity for both high-intensity and standard-field transfers. Increased buffering capacity and additional cooling mechanisms enable longer transfer times than are feasible with semi-dry transfers. Some tank transfer systems offer flexible electrode positions that, when combined with variable voltages, provide a choice of high-intensity, rapid transfer or longer, more quantitative transfer over a broad range of molecular weights.

Semi-dry transfers, on the other hand, are necessarily rapid and of high intensity. In a semi-dry transfer system, the distance between electrodes is determined only by the thickness of the gel-membrane sandwich and buffering and cooling capacity is limited to the buffer in the filter paper. As a result, the field strength is maximized in semi-dry systems, and the limited buffering and cooling capacity restricts the transfer time. Though power conditions may be varied with the power supply, semi-dry transfers often operate best within a narrow range of settings.

## Selecting Power Supply Settings

Power supplies that are used for electrophoresis hold one parameter constant (either voltage, current, or power). The PowerPac™ HC and PowerPac™ Universal power supplies also have an automatic crossover capability that allows the power supply to switch over to a variable parameter if a set output limit is reached. This helps prevent damage to the transfer cell.

During transfer, if the resistance in the system decreases as a result of Joule heating, the consequences are different and depend on which parameter is held constant.

### Transfers Under Constant Voltage

If the voltage is held constant throughout a transfer, the current in most transfer systems will increase as the resistance drops due to heating (the exception is most semi-dry systems, where current will actually drop as a result of buffer depletion). Therefore, the overall power will increase during transfer and more heating will occur. Despite the increased risk of heating, a constant voltage ensures that field strength will remain constant, providing the most efficient transfer possible. Use of the cooling elements available with the various tank blotting systems should prevent problems with heating.

### Transfers Under Constant Current

If the current is held constant during a run, a decrease in resistance will result in a decrease in voltage and power. Though heating will be minimized, proteins will be transferred more slowly due to decreased field strength.

### Transfers Under Constant Power

If the power is held constant during a transfer, changes in resistance will result in increases in current, but to a lesser degree than when voltage is held constant. Constant power is an alternative to constant current for regulating heat production during transfer.

## General Guidelines for Transfer Buffers and Transfer Conditions

Different transfer apparatus, when used with different buffers, will require different power settings. Tables 2.5, 2.6, and 2.7 provide general guidelines for the voltage and current settings recommended for selected buffer systems. Transfer times will need to be increased for gradient gels and may need to be decreased for low molecular weight proteins. The values presented below are guidelines — transfer conditions should be optimized for every transfer application.

Cooling is generally required for all high-intensity transfers (except for the Trans-Blot SD) and is recommended for long, unsupervised runs.

**Table 2.5. Guide to power settings for SDS-PAGE gels (Towbin buffer).**

	Standard (Overnight)	High-Intensity
Trans-Blot cell		
Plate electrodes	10 V/100 mA, 16 hr	50–100 V/700–1,600 mA, 30–60 min
Wire electrodes	30 V/100 mA, 16 hr	100–200 V/300–800 mA, 30 min–4 hr
Trans-Blot Plus cell	30 V/0.5 A, 16 hr	100 V/1,500 mA, 60 min
Mini Trans-Blot cell	30 V/90 mA, 16 hr	100 V/350 mA, 60 min
Criterion blotter		
Plate electrodes	10 V/50–80 mA, 16 hr	100 V/750–1,000 mA, 30 min
Wire electrodes	10 V/30–40 mA, 16 hr	100 V/380–500 mA, 60 min
Trans-Blot SD cell	N/A	Mini gels: 10–15 V/5.5 mA/cm <sup>2</sup> , 10–30 min Large gels: 15–25 V/3 mA/cm <sup>2</sup> , 30–60 min

**Table 2.6. Guide to power settings for native gels (Towbin buffer, no methanol).**

	Standard (Overnight)	High-Intensity
Trans-Blot cell		
Plate electrodes	10 V/100 mA, 16 hr	50–100 V/700–1,500 mA, 30–60 min
Wire electrodes	30 V/100 mA, 16 hr	100–200 V/300–800 mA, 30 min–4 hr
Trans-Blot Plus cell	10–30 V/0.15–0.5 A, 16 hr	100–130 V/1.7–2.3 A, 15–60 min
Mini Trans-Blot cell	30 V/90 mA, 16 hr	100 V/350 mA, 1 hr
Criterion blotter		
Plate electrodes	10 V/50 mA, 16 hr	100 V/830–1,000 mA, 30 min
Wire electrodes	10 V/50 mA, 12 hr	100 V/530–600 mA, 30 min
Trans-Blot SD cell	N/A	Mini gels: 10–15 V/5.5 mA/cm <sup>2</sup> , 10–30 min Large gels: 15–25 V/3 mA/cm <sup>2</sup> , 30–60 min

**Table 2.7. Guide to power settings for isoelectric focusing gels, native gels, basic proteins, and acid-urea gels (0.7% acetic acid).**

	Standard (Overnight)	High-Intensity
Trans-Blot cell		
Plate electrodes	15 V/200 mA, 16 hr	30–60 V/600–1,000 mA, 30–60 min
Wire electrodes	30 V/200 mA, 16 hr	100–150 V/550–850 mA, 30 min–4 hr
Trans-Blot Plus cell	10–30 V/0.15–0.55 A, 16 hr	100–125 V/1.9–2.4 A, 15–60 min
Mini Trans-Blot cell	30 V/10 mA, 16 hr	100 V/350 mA, 1 hr
Criterion blotter		
Plate electrodes	10 V/50 mA, 16 hr	100 V/980–1,200 mA, 30 min
Wire electrodes	10 V/50 mA, 16 hr	100 V/500–800 mA, 30 min
Trans-Blot SD cell	N/A	Mini gels: 10–15 V/5.5 mA/cm <sup>2</sup> , 10–30 min Large gels: 15–25 V/3 mA/cm <sup>2</sup> , 30–60 min



# Performing the Transfer

This chapter provides an overview of the steps and protocols involved in performing protein transfer. General advice for ensuring optimal results is also given. Detailed protocols and advice for each apparatus and transfer method are available in the relevant product instruction manuals. Information about choices of membranes, transfer buffers, and power settings was discussed in Chapter 2. Methods for protein detection are discussed in Chapter 4.

## Electrophoretic Transfer

---

Overall, the procedures and principles for semi-dry and tank transfers are the same. Gels and membranes must be prewet and equilibrated with transfer buffer and the gel/membrane sandwich must be placed into the transfer apparatus in the correct orientation to ensure transfer of proteins to the membrane.

## Performing a Tank Transfer

---

### Preparing the Transfer Buffer, Gels, and Tank Assembly

1. Prepare the transfer buffer in amounts that will suffice for gel equilibration, sandwich assembly, and electrophoresis. See the instruction manual for your particular tank transfer system for guidelines. See the Appendix at the end of this manual for buffer formulations.
  - Use only high-quality, analytical grade methanol. Impure methanol can cause increased transfer buffer conductivity and poor transfer
  - Reusing the transfer buffer is not advised, since the buffer will likely lose its ability to maintain a stable pH during transfer. Diluting transfer buffers below their recommended levels is also not advised, since this will decrease their buffering capacity
  - Do not adjust the pH of transfer buffers unless this is specifically indicated. Adjusting the pH of transfer buffers when not indicated will result in increased buffer conductivity, manifested by higher initial current output and decreased resistance
  - Increased SDS in the transfer buffer leads to increased protein transfer from the gel, but decreased binding of the protein to nitrocellulose membrane. PVDF membrane can be substituted for nitrocellulose when SDS is used in the transfer buffer
  - Addition of SDS will increase the relative current, power, and heating during transfer, and may also affect antigenicity of some proteins
  - Increased methanol in the transfer buffer leads to decreased protein transfer from the gel and increased binding of the protein to nitrocellulose membrane

2. Rinse gels briefly in ddH<sub>2</sub>O and equilibrate for 15 min in transfer buffer.
  - All gels should be equilibrated in transfer buffer to remove contaminating electrophoresis buffer salts. If salts are not removed, they will increase the conductivity of the transfer buffer and the amount of heat generated during the transfer. Also, gels will shrink or swell to various degrees in the transfer buffer depending on the acrylamide percentage and the buffer composition. Equilibration allows the gel to adjust to its final size prior to electrophoretic transfer. Equilibration is not necessary when the same buffer is used for both electrophoresis and transfer (for example, native gel transfers)
3. Place the transfer tank onto a magnetic stirplate and assemble the transfer tank with the anode and cathode cards in the correct position and orientation.
4. Add enough transfer buffer to the tank to fill it approximately halfway, add a stirbar, and begin stirring.
  - The transfer buffer should be stirred during the course of all tank transfers. This will help to maintain uniform conductivity and temperature during electrophoretic transfer. Failure to properly control transfer buffer temperature results in poor transfer and poses a potential safety hazard
5. If needed, set up the cooling system for the tank transfer system. Follow instructions in the instruction manual.
  - Electrophoretic transfer entails large power loads and, consequently, heat generation. The tanks are effective thermal insulators and limit the efficient dissipation of heat. Therefore, placing blotting cells in a coldroom is not an adequate means of controlling transfer buffer temperature. The use of additional cooling devices, such as the cooling coil or Bio-Ice™ units, is required for high-intensity field transfers and is recommended for long unsupervised runs

**Fig. 3.1. Transfer assembly for a tank transfer system (Trans-Blot cell).** The cassette (1) holds the gel (2) and membrane (3) while fiber pads and filter paper (4) on both sides provide complete contact within the gel sandwich. The gel cassette is inserted vertically in the buffer tank (5).

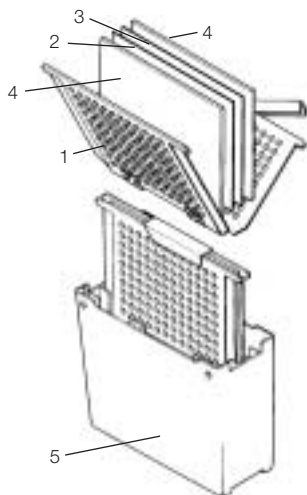

### Assembling the Gel and Membrane Sandwich

Each gel sandwich will contain the gel and membrane sandwiched between pieces of blot absorbent filter paper (Figure 3.1). To prevent contamination, always wear gloves when handling the gels, membranes, and filter paper.

Optional gel/cassette assembly trays are available for the Criterion™ blotter and Trans-Blot® Plus cell (see Ordering Information). These trays are large enough to accommodate the gel holder cassette during sandwich assembly.

6. For each gel, cut one piece of membrane and two pieces of filter paper to the dimensions of the gel. Precut membranes and filter papers are available (see Ordering Information).
7. Equilibrate the membranes in transfer buffer.
  - Membranes must be thoroughly wetted in transfer buffer prior to assembly of the gel and membrane sandwich. Nitrocellulose membranes may be wetted directly with transfer buffer, while PVDF membranes must be thoroughly soaked in 100% methanol before being soaked in transfer buffer
8. Place a fiber pad on top of the black side of the cassette, submerged in buffer. Push on the fiber pad with gloved fingertips to thoroughly wet the pad.
9. Place a piece of filter paper on top of the fiber pad (it should be wetted immediately).
10. Gently place the preequilibrated gel on top of the filter paper. Run a wet, gloved finger across the gel to remove any air bubbles that may be trapped underneath the gel.

11. Carefully place the preequilibrated membrane on top of the gel. Make sure the membrane is correctly positioned as it touches the gel. To avoid ghost prints and other artifacts, do not move the membrane after it is positioned. Use the roller to remove any air bubbles and to ensure proper contact between the gel and membrane.
12. Wet a second piece of filter paper in transfer buffer and place it on top of the membrane.
13. Soak a fiber pad in transfer buffer and place it on top of the filter paper.
14. Once the cassette is closed and locked, insert it into the tank with the latch side up. Make sure the black cassette plate faces the black electrode plate.

### Performing the Transfer

15. Add transfer buffer to the tank until the buffer level reaches the fill line.
16. Place the lid on top of the cell, making sure that the color-coded cables on the lid are attached to the electrode cards of the same color. Reversing the orientation of the cables will cause irreversible damage to the plate electrodes.
17. Connect the cables to the power supply and begin the run. See Chapter 2 and the instruction manual for suggested run times with various buffers.
  - Initial test runs should be used to evaluate the transfer efficiency at various field strengths (V/cm), staying within the recommended guidelines of each instrument. Transfers under high power should be monitored carefully and cooling used when indicated
  - An initial test run should be performed to determine the time required for complete transfer. Times vary from 15 min to overnight and depend on many factors, including the power setting, the size and shape of the protein, etc.
18. Upon completion of the run, remove the cassettes and disassemble the gel and membrane sandwich. Rinse the membrane briefly in ddH<sub>2</sub>O to ensure that no residual gel pieces or sample adhere to the membrane.

## Performing a Semi-Dry Transfer

---

### Preparing the Transfer Buffer and Gels

1. Prepare the transfer buffer in amounts that will suffice for gel equilibration, sandwich assembly, and electrophoresis. See the Appendix for buffer formulations.
2. Rinse gels briefly in ddH<sub>2</sub>O and equilibrate for 15 min in transfer buffer.
  - All gels should be equilibrated in transfer buffer to remove contaminating electrophoresis buffer salts. If salts are not removed, they will increase the conductivity of the transfer buffer and the amount of heat generated during the transfer. Also, gels will shrink or swell to various degrees in the transfer buffer depending on the acrylamide percentage and the buffer composition. Equilibration allows the gel to adjust to its final size prior to electrophoretic transfer. Equilibration is not necessary when the same buffer is used for both electrophoresis and transfer (for example, native gel transfers)

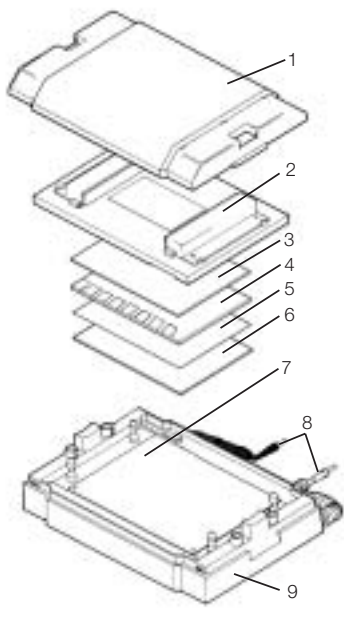

**Fig. 3.2. Transfer assembly for the Trans-Blot SD semi-dry transfer system.**

1. Safety lid
2. Cathode assembly with latches
3. Filter paper
4. Gel
5. Membrane
6. Filter paper
7. Spring-loaded anode platform mounted on four guideposts
8. Power cables
9. Base

### Assembling the Gel and Membrane Sandwich

Each gel sandwich will contain the gel and membrane sandwiched between one to three pieces of blot absorbent filter paper (Figure 3.2).

- If extra thick filter paper is used, only one sheet on each side will be necessary
- If thick or thin filter paper is used, two or three sheets on each side of the gel must be used, respectively

The amount of filter paper used for semi-dry transfers is important because the filter paper serves as the only reservoir for the transfer buffer. To prevent contamination, always wear gloves when handling the gels, membranes, and filter paper.

3. For each gel, cut one piece of membrane and two to six pieces of filter paper to the dimensions of the gel. Precut membranes and filter papers are available (see Ordering Information).
4. Soak the filter paper in transfer buffer.
5. Equilibrate the membranes in transfer buffer.
  - Membranes must be thoroughly wetted in transfer buffer prior to assembly of the gel and membrane sandwich. Nitrocellulose membranes may be wetted directly with transfer buffer, while PVDF membrane must be thoroughly soaked in 100% methanol before being soaked in transfer buffer
6. Remove the safety cover and stainless-steel cathode assembly.
7. Place a presoaked sheet of extra thick filter paper onto the platinum anode. Roll a pipet or roller over the surface of the filter paper (like a rolling pin) to push out all air bubbles. If thick or thin filter paper is used instead, repeat with one or two more sheets of buffer-soaked paper.
8. Carefully place the presoaked membrane on top of the filter paper. Roll out all air bubbles.
9. Gently place the preequilibrated gel on top of the membrane, aligning the gel on the center of the membrane. Transfer will be incomplete if any portion of the gel is outside of the membrane. The membrane and filter paper should be cut to the same size as the gel. Remove all air bubbles.
  - To avoid ghost prints and other artifacts, do not move the membrane and/or gel after it is positioned. Use the roller to remove any air bubbles and to ensure proper contact between the gel and membrane
10. Wet a second piece of presoaked extra thick filter paper on top of the membrane. Roll a pipet or roller over the surface of the filter paper to push out all air bubbles. If thick or thin filter paper is used instead, repeat with one or two more sheets of buffer-soaked paper. Wipe up any excess buffer around the gel/membrane sandwich to prevent current leaks.
11. Carefully place the cathode onto the stack.
12. Place the safety cover back onto the unit.

### Performing the Transfer

13. Connect the cables to the power supply and begin the run. See Chapter 2 and the instruction manual for suggested run times with various buffers.
14. Upon completion of the run, remove the cathode assembly and disassemble the gel and membrane sandwich. Rinse the membrane briefly in ddH<sub>2</sub>O to ensure that no residual gel pieces or sample adhere to the membrane.

## Microfiltration

---

Microfiltration with the Bio-Dot® and Bio-Dot SF involves presoaking the transfer membrane as described, assembly of the transfer apparatus, application of the vacuum, and application of the sample. Detailed protocols are provided in the Bio-Dot and Bio-Dot SF instruction manuals. Some advice for microfiltration transfers is provided below.

### Application of the Vacuum

Apply the vacuum only until solutions are removed from the sample wells, then adjust the flow valve so that the unit is exposed only to atmospheric pressure and disconnect the vacuum. For best sample binding, the entire sample should be filtered by gravity flow without vacuum.

During the assay, do not leave the unit with the vacuum on. This may dehydrate the membrane and may cause halos around the wells.

### Proper Drainage

Proper positioning of the flow valve relative to the level of the apparatus is important for proper drainage. The speed of drainage is determined by the difference in hydrostatic pressure between the fluid in the sample wells and the opening of the flow valve that is exposed to the atmosphere. When the flow valve is positioned below the sample wells, proper drainage may be achieved.

### Flow Valve — Extended Incubations

If a prolonged or overnight incubation is desired, adjust the flow valve so that the vacuum manifold is closed off from both the vacuum source and atmosphere before applying the samples. In this configuration, solutions will remain in the sample wells with less than a 10% loss of volume during extended incubations.

### Flow Valve — Gentle Vacuum

To apply a gentle vacuum to the apparatus, adjust the flow valve so that it is open to the atmosphere, the vacuum source, and the vacuum manifold while the vacuum is on. Then, use a finger to cover the valve port that is exposed to the atmosphere. The pressure of your finger on the valve will regulate the amount of vacuum reaching the manifold.

### Filtering or Centrifugation of Samples

For best results, filter or centrifuge samples to remove particulate matter that might restrict the flow of solutions through the membrane.

### Air Bubbles

Air bubbles trapped in the wells will prevent the sample from binding to the membrane. Air bubbles may be removed by gently pipeting the solution up and down.

### Membrane Removal

The best method for removing the membrane from the Bio-Dot units is to leave the vacuum on while loosening the screws and removing the sample template. Then, turn off the vacuum and remove the membrane.



# Detection

## Detection Methods

Once proteins have been transferred to a membrane, they can be visualized using a variety of specialized detection reagents (Figure 4.1). Protein standards are useful for monitoring transfer efficiency of the experiment and serve as molecular weight markers for calibration of blot patterns. Total protein stains allow visualization of the protein pattern on the blot and immunological detection methods, employing antibody or ligand conjugates, allow visualization of specific proteins of interest. This chapter reviews the various protein standards, total protein stains, and immunological detection methods available.

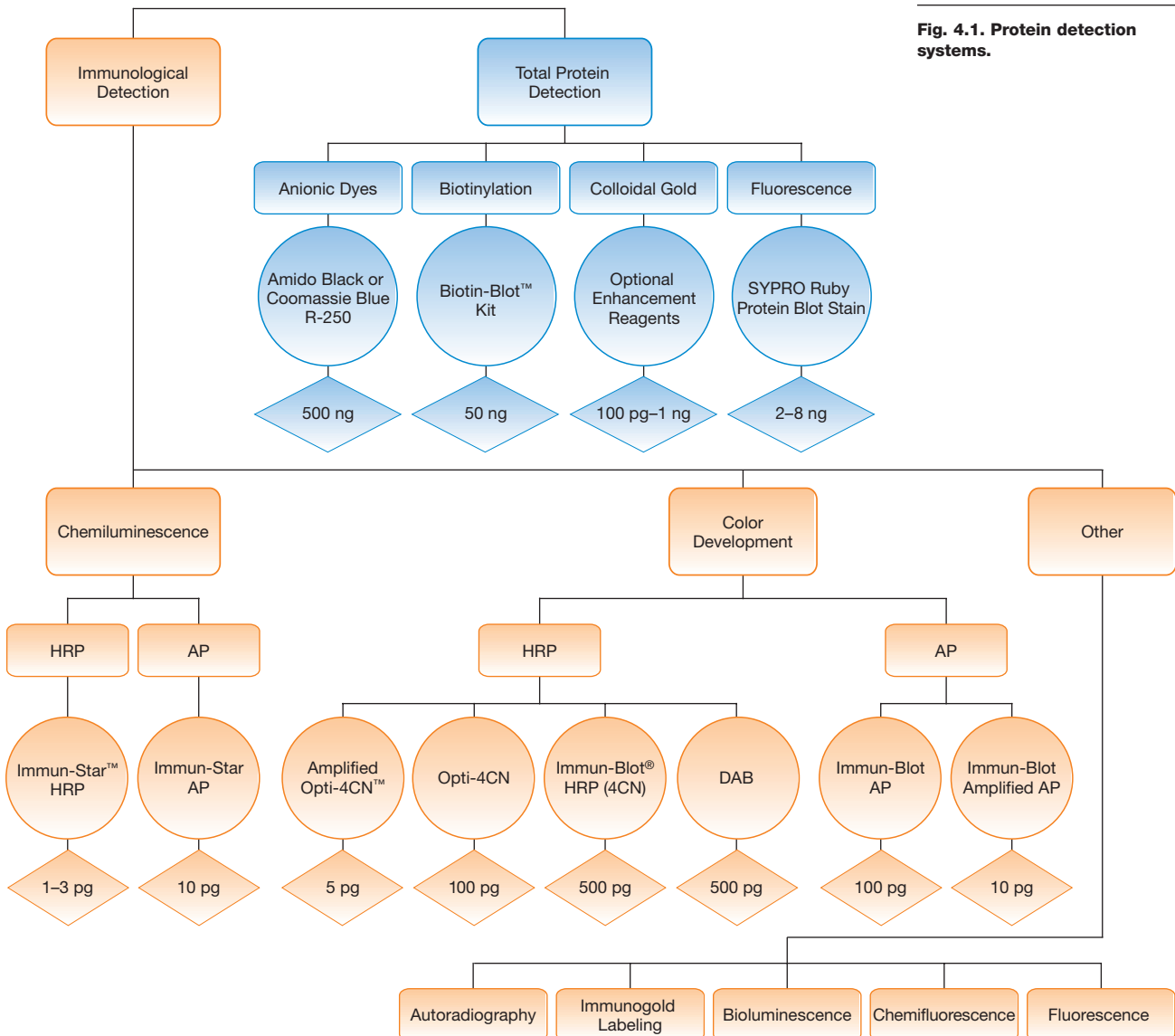

**Fig. 4.1. Protein detection systems.**

## Protein Standards

Protein standards are mixtures of well-characterized or recombinant proteins and are routinely used in electrophoresis and blotting applications. Protein standards:

- Provide a reference for determining the molecular weight of proteins identified by antibody or ligand probes
- Are useful for monitoring transfer efficiency
- Serve as controls to ensure proper location of transferred bands in repetitive screening experiments

Protein standards are available as either prestained, unstained, or biotinylated sets of purified or recombinant proteins. In general, prestained standards allow easy and direct visualization of their separation during electrophoresis and of their transfer to membranes. Though prestained standards can also be used for estimation of molecular weight of separated proteins, unstained or biotinylated standards are recommended for the most accurate molecular weight determination. Applications of Bio-Rad's blotting standards are summarized in Table 4.1.

**Table 4.1. Blotting standard selection guide.**

Product Name	Application	Comparative Information
<b>Prestained Standards</b>		
Precision Plus Protein dual color standards	<ul style="list-style-type: none"> <li>• Molecular weight estimation</li> <li>• Assessing transfer efficiency</li> <li>• Monitoring electrophoretic separation</li> </ul>	<ul style="list-style-type: none"> <li>• Sharpest prestained bands</li> <li>• Best for molecular weight estimation</li> <li>• 2 colors plus reference bands</li> <li>• Load-and-go format; no dilution</li> <li>• Recombinant</li> </ul>
Precision Plus Protein all blue standards	<ul style="list-style-type: none"> <li>• Molecular weight estimation</li> <li>• Assessing transfer efficiency</li> <li>• Monitoring electrophoretic separation</li> </ul>	<ul style="list-style-type: none"> <li>• Sharpest prestained bands</li> <li>• Best for molecular weight estimation</li> <li>• Blue bands plus reference bands</li> <li>• Load-and-go format; no dilution</li> <li>• Recombinant</li> </ul>
Precision Plus Protein Kaleidoscope™ standards	<ul style="list-style-type: none"> <li>• Molecular weight estimation</li> <li>• Assessing transfer efficiency</li> <li>• Monitoring electrophoretic separation</li> </ul>	<ul style="list-style-type: none"> <li>• Sharpest prestained bands</li> <li>• Best for molecular weight estimation</li> <li>• 5 bright colors for easy band identification</li> <li>• Load-and-go format; no dilution</li> <li>• Recombinant</li> </ul>
Kaleidoscope prestained standards	<ul style="list-style-type: none"> <li>• Assessing transfer efficiency</li> <li>• Monitoring electrophoretic separation</li> </ul>	<ul style="list-style-type: none"> <li>• Individually colored proteins</li> <li>• Prestained bands</li> <li>• Available in broad molecular weight and polypeptide ranges</li> <li>• Each lot individually calibrated (molecular weight will vary between lots)</li> </ul>
Prestained SDS-PAGE standards	<ul style="list-style-type: none"> <li>• Assessing transfer efficiency</li> <li>• Monitoring electrophoretic separation</li> </ul>	<ul style="list-style-type: none"> <li>• Economical</li> <li>• Available in low, high, and broad molecular weight ranges</li> <li>• Prestained all blue bands</li> <li>• Each lot individually calibrated (molecular weight will vary between lots)</li> </ul>
<b>Unstained Standards</b>		
Precision Plus Protein unstained standards	<ul style="list-style-type: none"> <li>• Molecular weight determination on blots</li> </ul>	<ul style="list-style-type: none"> <li>• Integral <i>Strep</i>-tag sequence allows detection of standards along with antigen of interest (2-step detection)</li> <li>• Sharpest unstained bands</li> <li>• 10-band, well-spaced ladder</li> </ul>
Biotinylated standards	<ul style="list-style-type: none"> <li>• Molecular weight determination on blots</li> </ul>	<ul style="list-style-type: none"> <li>• Simultaneous detection with immunostained antigens</li> <li>• Available in low, high, and broad molecular weight ranges</li> </ul>
SDS-PAGE unstained standards	<ul style="list-style-type: none"> <li>• Molecular weight determination on blots</li> </ul>	<ul style="list-style-type: none"> <li>• Separate detection required using a total protein stain such as colloidal gold, Amido Black, or Ponceau S</li> <li>• Available in low, high, and broad molecular weight ranges</li> </ul>



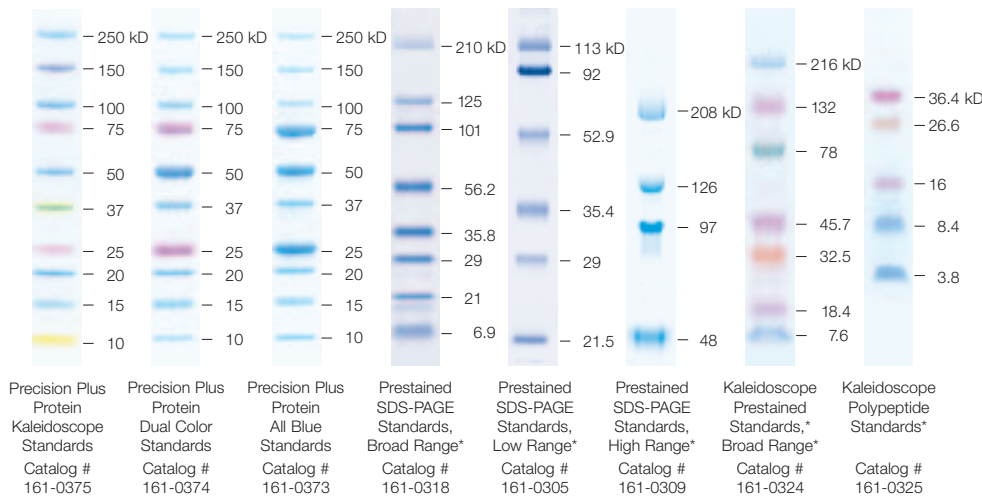

**Fig. 4.2. Bio-Rad's selection of prestained blotting standards.** Bio-Rad's prestained standards are available in low, high, and broad molecular weight ranges.

\* MW may vary from lot to lot

### Prestained Standards for Western Blotting

Bio-Rad provides both recombinant and natural prestained standards. The ability to visualize prestained standards during electrophoresis makes them ideal for monitoring protein separation during gel electrophoresis. The ease in transferring to the blot also make them popular for monitoring transfer efficiency and the general location of antigens in repetitive screening assays (Tsang et al. 1984). This, combined with recent improvements made in their design and manufacture, has made prestained standards an excellent choice for

estimations of molecular weights on western blots. Figure 4.2 and Table 4.2 summarize Bio-Rad's prestained standards.

#### Recombinant Prestained Standards

Advances in molecular biology and genetic engineering have led to the development of recombinant protein standards for electrophoresis. With recombinant technology, specific attributes, such as evenly spaced molecular weights or customization of proteins with affinity tags for easy detection, may be designed and engineered into sets of protein standards. Bio-Rad's recombinant standards are in the Precision Plus Protein standards family.

**Table 4.2. Composition and molecular weights (in kD) of prestained standards.**

**A**, recombinant prestained standards; **B**, natural prestained standards.

<b>A</b>	<b>B</b>					
<b>Precision Plus Protein Standards Family*</b>	<b>Kaleidoscope Prestained Standards**</b>	<b>Kaleidoscope Polypeptide Standards**</b>	<b>Prestained High Range**</b>	<b>Prestained Low Range**</b>	<b>Prestained Broad Range**</b>	<b>Protein</b>
250	202	–	205	–	208	Myosin
150	133	–	118	–	115	β-Galactosidase
100	–	–	–	107	–	Phosphorylase b
75	71	–	85	76	79.5	BSA
50	–	–	47	52	49.5	Ovalbumin
37	41.8	38.6	–	36.8	34.8	Carbonic anhydrase
25	30.6	25	–	27.2	28.3	Soybean trypsin inhibitor
20	–	–	–	–	–	–
15	17.8	16.3	–	19	20.4	Lysozyme
10	6.9	7.8	–	–	7.2	Aprotinin
–	–	3.4	–	–	–	Insulin

\* The molecular weights for the Precision Plus Protein family do not vary from lot to lot.

\*\* The molecular weights for the natural prestained standards are from a representative lot of standards; they will vary from lot to lot.

**Fig. 4.3. Exceptional linearity of Precision Plus Protein™ standards.**

The standard curve was generated by plotting the log molecular weight (MW) versus the migration distance ( $R_f$ ) of each protein standard band through an SDS-PAGE gel. Precision Plus Protein Kaleidoscope standards showed  $r^2 = 0.996$ , demonstrating a very linear standard curve.

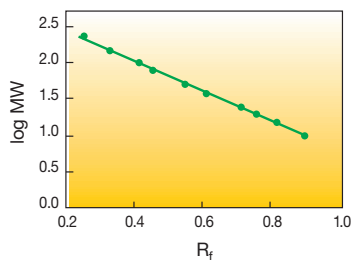
**Precision Plus Protein Prestained Standards**

Precision Plus Protein prestained standards are a blend of ten recombinant proteins and provide a ten-band, broad range molecular weight ladder (10–250 kD) with single (all blue), dual (dual color), or multicolored (Kaleidoscope) protein bands (Figure 4.2). The colors allow easy band referencing and blot orientation. Because the proteins in the Precision Plus Protein standards are recombinant, and the staining technology is optimized, their molecular weight does not vary from lot to lot. Dye labeling can be controlled more effectively, delivering homogeneous staining and tight, sharp bands. All Precision Plus Protein prestained standards (all blue, dual color, Kaleidoscope) deliver the most linear ( $r^2 > 0.995$ ) standard curve available for prestained standards (Figure 4.3). As a result, these standards may be used for highly accurate estimation of molecular weight across a broad size range.

**Fig. 4.4. Bio-Rad's unstained and biotinylated protein blotting standards.**

The biotinylated standards were detected with avidin-AP and BCIP/NBT color development reagents.

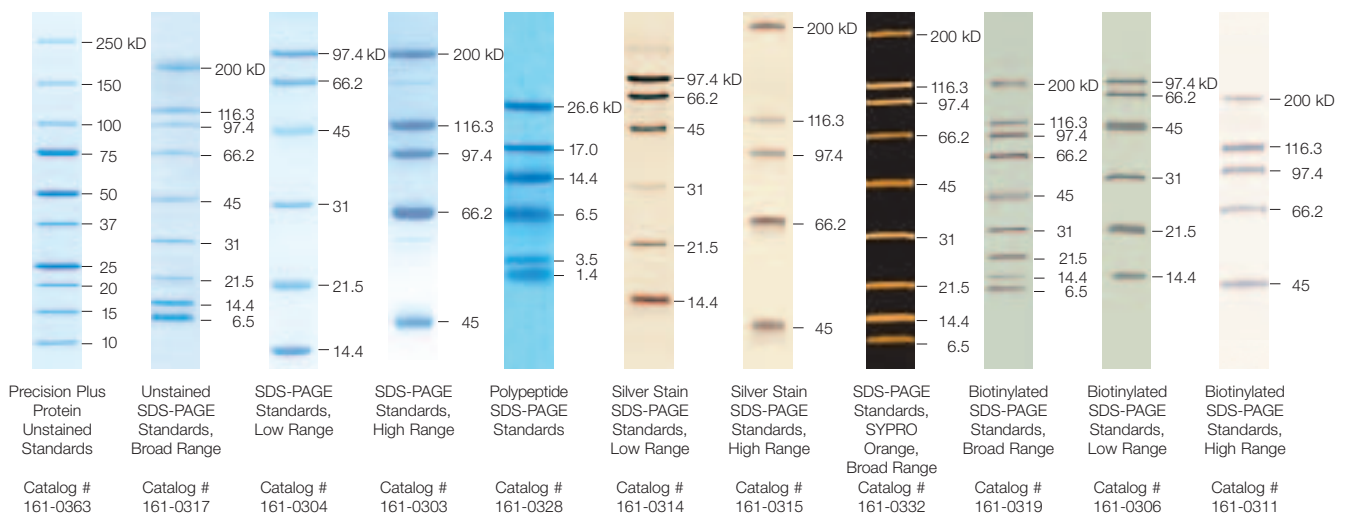
**Natural Prestained SDS-PAGE Standards**

Natural molecular weight standards are blended from naturally occurring proteins, often providing a familiar band pattern. Although very effective for monitoring gel separation and transfer efficiency, they have an inherent variability in the amount and location of dye that covalently binds to the protein. This may produce broader bands than seen in recombinant prestained standards or in unstained standards, making them less desirable for molecular weight estimations.

**Kaleidoscope Standards**

Kaleidoscope prestained standards contain individually colored proteins that allow instant band recognition on western blots or gels. The molecular weights of the proteins in each lot are calibrated against unstained SDS-PAGE standards. The Kaleidoscope standards are available in broad or low molecular weight (polypeptide) formulations; polypeptide standards are designed for use with Tricine gels when resolving small proteins and peptides.

**Prestained SDS-PAGE Standards**

Naturally occurring prestained SDS-PAGE standards are available in specific size ranges: low, high, and broad.

**Table 4.3. Composition and molecular weights (in kD) of unstained standards.**

A, recombinant unstained standards; B, natural unstained standards.

Precision Plus Protein Unstained Standards	SDS-PAGE and Biotinylated Standards			
	Low Range	High Range	Broad Range	Protein
250	–	200	200	Myosin
150	–	116.25	116.25	β-Galactosidase
100	97.4	97.4	97.4	Phosphorylase b
75	66.2	66.2	66.2	BSA
50	45	45	45	Ovalbumin
37	31	–	31	Carbonic anhydrase
25	21.5	–	21.5	Soybean trypsin inhibitor
20	–	–	–	–
15	14.4	–	14.4	Lysozyme
10	–	–	6.5	Aprotinin

## Unstained Standards for Western Blotting

Bio-Rad provides recombinant, natural, and biotinylated unstained standards. Since unstained standards contain only the protein itself, they do not exhibit the variability in molecular weight that is often seen with prestained standards. Therefore, unstained standards, biotinylated standards, or standards with an affinity tag for blot detection deliver almost 100% molecular weight accuracy across a linear curve and are recommended for the most accurate molecular weight determinations for gels or blots. Figure 4.4 and Table 4.3 summarize the composition and molecular weights of Bio-Rad's unstained standards.

### Precision Plus Protein Unstained Standards

Precision Plus Protein unstained standards provide a recombinant ten-band, broad range molecular weight ladder (10–250 kD). These standards contain an affinity *Strep*-tag peptide that displays an intrinsic binding affinity towards StrepTactin, a genetically modified form of streptavidin. It is the high-affinity binding of the *Strep*-tag sequence to StrepTactin that allows convenient and simultaneous detection of both proteins and standards on western blots (Figure 4.5) using either colorimetric or chemiluminescent methods.

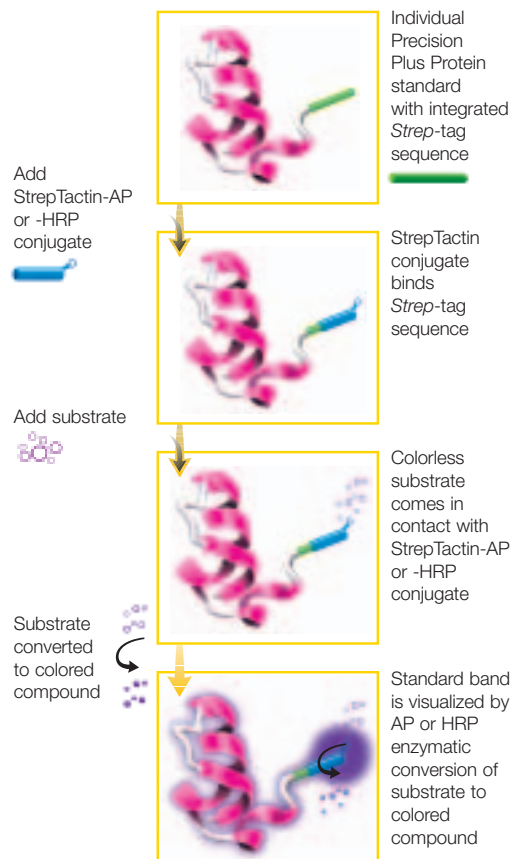
**Fig. 4.5. Overview of the StrepTactin detection system.**

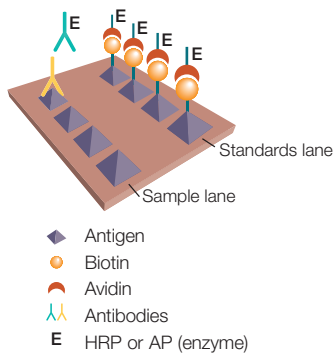

**Fig. 4.6. Detection of biotinylated standards.**

Following transfer and addition of antigen-specific primary antibody, avidin-HRP or avidin-AP is added to the conjugated secondary antibody solution and applied to the membrane. Avidin binds to the biotinylated standards while the secondary antibody binds to the primary antibody. The standards and the protein of interest are detected simultaneously using the appropriate color development reagent system.

### Biotinylated Standards

Biotinylated protein standards have been developed specifically for accurate molecular weight determinations in blotting applications (Della-Penna et al. 1986). These proteins have been treated with a limited amount of biotin. Since biotin is a relatively small molecule, the mobilities of the standard proteins in SDS-PAGE gels are not altered. The biotinylated proteins form sharp, tight bands with well-defined molecular weights and are processed simultaneously with the immunostained antigens. Therefore, they provide fast, accurate, reproducible determinations of antigen molecular weights directly on the membrane. Bio-Rad's biotinylated standards are available in three molecular weight ranges.

Biotinylated standards are easily detected using avidin or streptavidin conjugated with horseradish peroxidase (avidin-HRP) or alkaline phosphatase (avidin-AP) (Figure 4.6).

### Unstained SDS-PAGE Standards

The protein markers used for SDS-PAGE gels form very tight bands that transfer reproducibly to membranes. Molecular weight determination with these proteins, however, may require cutting the lane of standards from the membrane and using a separate total protein stain for identification. After visualization, the cut strip must be realigned with the probed membrane. If anionic dye is used to stain the strip of standards, the dye solvent may shrink nitrocellulose membrane, making it necessary to measure  $R_f$  values and calculate molecular weight information. Alternatively, the entire blot may be stained with a washable anionic total protein dye like Ponceau S (see Anionic Dyes, below) and the positions of the standards on the blot marked with a pencil. SDS-PAGE standards are available in three molecular weight ranges.

## Total Protein Staining

Total protein staining of a membrane provides a visual image of the complete protein pattern. This information is required for the full characterization of specific antigens detected in a complex protein mixture. Since SDS-PAGE gels shrink during staining procedures, comparison of an immunologically probed membrane to a stained gel is not practical. Instead, the

exact location of a specific antigen in relation to other proteins is determined by comparing two blotted membranes, one of which has been probed with an antibody and the other stained for total protein. Table 4.4 compares the advantages and disadvantages of several total protein staining techniques.

**Table 4.4. Comparison of total protein staining methods.**

Method	Sensitivity	Advantages	Disadvantages
Anionic dyes	100–1,000 ng	Inexpensive, rapid	Low sensitivity; shrinks membrane
Colloidal gold (enhanced)	1 ng (10–100 pg)	Very sensitive, rapid; optional enhancement increases detection sensitivity	Expensive
Biotinylation	50 ng	Sensitive assay	Results fade with time
Fluorescence	2–8 ng	Mass spectrometry compatible	UV fluorescence detection system required

## Anionic Dyes

The first techniques developed for total protein staining of blotted membranes used the same anionic dyes commonly used for staining proteins in polyacrylamide gels. Dyes that became popular for detecting proteins bound to membranes include Amido Black (Towbin et al. 1979), Coomassie Brilliant Blue R-250 (Burnette 1981), Ponceau S, and Fast Green FCF (Reinhart and Malamud 1982). Of the anionic dyes used, Amido Black and Ponceau S are the best choices because they destain rapidly in distilled water or low concentrations of methanol and produce very little background staining. Coomassie Brilliant Blue gives high background staining, even after long destaining procedures. Fast Green is not tightly bound to the proteins, so the dye can be easily removed after visualization to allow subsequent immunological probing.

These dyes are easy to prepare and they stain proteins quickly, but they are relatively insensitive when compared to immunological detection assays. The stains that require alcohol-containing solutions (for example, Amido Black, Coomassie Brilliant Blue, Fast Green FCF) for solubility can shrink nitrocellulose membranes, making direct comparison of an immunologically detected antigen to the total protein on the stained membrane difficult. Amido Black 10B and Coomassie Blue R-250 are available from Bio-Rad.

## Colloidal Gold

An alternative to anionic dyes that provides detection sensitivities that rival those of immunological detection methods is colloidal gold (Moeremans et al. 1987, Rohringer and Holden 1985). When a solution of colloidal gold particles is incubated with proteins bound to a nitrocellulose or PVDF membrane, the gold binds to the proteins through electrostatic adsorption. The resulting gold-protein complex produces a transient, reddish-pink color due to the optical properties of colloidal gold. This gold-protein interaction is the basis for total protein staining with colloidal gold as well as for specific, immunogold detection (see Immunogold Detection below).

Silver enhancement of the colloidal gold signal produces a stable, dark brown reaction product and enhances sensitivity down to 10 pg of protein. The method of silver enhancement makes use of the fact that gold particles can reduce silver ions in solution; this reduction leads to deposition of the silver on top of the gold and the effective growth of the metallic particle. Since methanol is not required, colloidal gold with silver enhancement has the advantage over the anionic dyes of not shrinking the membrane during staining. Exact comparisons between membranes stained for total protein and membranes used for immunological detection are possible.

Bio-Rad's colloidal gold total protein stain is provided ready to use with an optional gold enhancement kit. Alternatively, the colloidal gold stain and silver enhancement kit are available as components of the enhanced colloidal gold total protein detection kit.

## Biotinylation

Bio-Rad's Biotin-Blot total protein detection kit provides a sensitive total protein detection method that takes advantage of the high-affinity binding of avidin to biotin. This method uses NHS-biotin to biotinylate all proteins on the membrane surface, followed by incubations with an avidin-horseradish peroxidase (avidin-HRP) conjugate and the HRP color-development reagent to detect the biotinylated proteins. The assay is 10–50 times more sensitive than the anionic stains, and does not require methanol. Exact comparison of the immunologically detected membranes and membranes stained for total protein is possible.

## Fluorescence

Fluorescent protein stains like SYPRO Ruby, SYPRO Red, SYPRO Orange, and Deep Purple provide highly sensitive detection of proteins on blots as well as in gels. SYPRO Ruby protein blot stain allows detection as low as 2–8 ng. After staining, target proteins can be detected by colorimetric or chemiluminescent immunodetection methods, or analyzed by microsequencing or mass spectrometry with no interference from the protein stain.

## Immunological Detection Systems

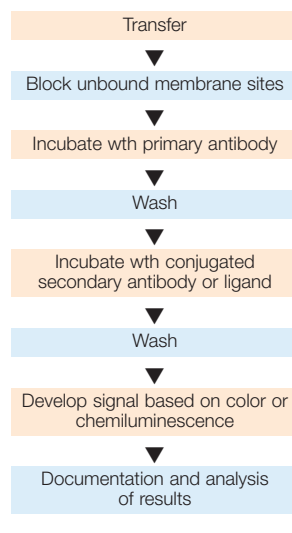

**Fig. 4.7. Basic immunological detection procedure.**

Immunological detection systems are used to identify specific proteins blotted to membranes. Though there are numerous systems available for immunological detection, the basic procedure for these assays varies very little.

The basic steps for immunological detection of a specific protein in a blot are summarized in Figure 4.7. After the proteins have been transferred to the membrane, the membrane is blocked, incubated with a primary antibody, washed, incubated with a secondary antibody, and washed again. The primary antibody is specific for the protein of interest, and the secondary antibody enables its detection (Figure 4.8). The secondary antibody can be radiolabeled, labeled with a

fluorescent compound or gold particles, or conjugated to an enzyme like AP or HRP. For many years, radiolabeled secondary antibodies were the method of choice for detection, but newer methods have evolved that are less hazardous and easier to use than radioactivity, yet maintain the same degree of sensitivity. Available detection methods now include — in addition to autoradiography of radiolabeled probes — colorimetric, chemiluminescent, bioluminescent, chemifluorescent, fluorescent, and immunogold detection.

## Blocking Reagents

Following transfer, unoccupied binding sites on the membranes must be blocked to prevent nonspecific binding of probes; failure to adequately saturate the membrane can lead to high background, since many probes are also proteins, and can also bind to the membrane.

A variety of blocking reagents are available, including gelatin, nonfat milk, and bovine serum albumin (BSA), which are compared in Table 4.5. It is often useful to optimize the detection system for minimal background with no loss of signal by testing several blocking agents. The type of membrane will also affect the selection of blocker. Formulations for the different blocking solutions are available in the Appendix of this manual.

## Antibody Incubations

An antibody is a protein that is synthesized by an animal in response to exposure to a foreign substance, or antigen. Antibodies (also called immunoglobulins) have specific affinity for the antigens that elicited their synthesis.

A typical experimental system utilizes two layers of antibody in the detection procedure. The primary antibody is directed against the target antigen; the antigen may be a ligand on a protein, the protein itself, a specific epitope on a protein, or a carbohydrate group. The secondary antibody is specific for the primary antibody; it is usually conjugated to an enzyme such as alkaline phosphatase (AP) or horseradish peroxidase

(HRP), and an enzyme-substrate reaction is part of the detection process (Figure 4.8).

Antibody incubations are generally carried out in antibody buffer containing Tris-buffered saline with Tween (TTBS) and a blocking reagent. Various formulations of antibody buffer are provided in the Appendix of this manual.

### Primary Antibodies

The primary antibody recognizes and binds to the target antigen on the membrane. For incubations with primary antibody, the entire blot must be covered with antibody-containing solution. The appropriate concentration or dilution (titer) of the primary antibody must be determined empirically for each new lot of primary antibody.

The optimal antibody concentration is usually considered to be the greatest dilution of antibody still resulting in a strong positive signal without background or nonspecific reactions. Generally, when serum or tissue culture supernatants are the source of primary antibody, a 1:100–1:1,000 dilution of the primary antibody in buffer is used. Chromatographically purified monospecific antibodies may be used at dilutions of 1:500–1:10,000, and a 1:1,000–1:100,000 dilution may be used when ascites fluid is the source of antibody. The Mini-PROTEAN® II multiscreen apparatus and mini incubation trays described at the end of this chapter are useful tools for determining antibody titer.

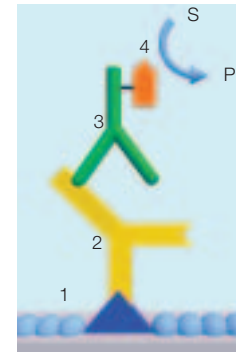

**Fig 4.8. Specific enzymatic detection of membrane-bound antigens.** 1, gelatin blocks unoccupied sites on the membrane; 2, primary antibody to a specific antigen is incubated with the membrane; 3, a blotting grade antibody-enzyme conjugate is added to bind to the primary antibody; 4, substrate reagent is then added to the blot. The enzyme catalyzes the substrate (S) to form a detectable product (P) at the site of the antigen-antibody complex.

**Table 4.5. Comparison of blocking reagents.**

Blocking Reagent	Membrane Compatibility	Recommended Concentration	Notes
Gelatin	Nitrocellulose	1–3%	Requires heat to solubilize
Nonfat dry milk, BLOTTO, blotting-grade blocker	Nitrocellulose, PVDF	0.5–5%	PVDF requires higher concentrations of nonfat milk than nitrocellulose
BSA	Nitrocellulose, PVDF	1–5%	PVDF requires higher concentrations of BSA than nitrocellulose
Tween 20	Nitrocellulose	0.05–0.3%	May strip some proteins from the blot

### Species-Specific Secondary Antibodies

Blotting-grade species-specific secondary antibodies are the detection reagents of choice. Secondary antibodies are specific for the isotype (class) and the species of the primary antibody (for instance, a goat anti-rabbit secondary antibody is an antibody generated in goat for detection of a rabbit primary antibody). Secondary antibodies bind to multiple sites on primary antibodies to increase detection sensitivity.

Secondary antibodies can be labeled and detected in a variety of ways. The antibody can be linked to a fluorescent compound or to gold particles, but most commonly the antibody is conjugated to an enzyme, such as HRP or AP. If the secondary antibody is biotinylated, biotin-avidin-HRP or -AP complexes can be formed. Addition of a suitable enzyme substrate results in production of a colored precipitate or fluorescent or chemiluminescent product through oxidation (by HRP) or dephosphorylation (by AP).

Since the purity of the reagents is critical to the success of the experiment, sera must be affinity purified to obtain only those antibodies directed against the particular IgG. Otherwise, background staining and false positive reactions due to nonspecific antibody binding may occur. The purified antibody solution should be cross-adsorbed

against an unrelated species; for example, human IgG for anti-rabbit and anti-mouse antibodies, and bovine IgG for anti-human reagents, to remove antibodies that are not specific for the species of interest. Because blotting grade antibodies are directed to both heavy and light chains of the IgG molecules, the reagents can be used to identify IgM- and IgA-class antibodies as well as all subtypes of IgG antibodies.

Secondary antibodies are generally used at dilutions of ~1:3,000.

### Antibody-Specific Ligands

Protein A and protein G are bacterial cell surface proteins that bind to the Fc regions of immunoglobulin molecules (Akerstrom et al. 1985, Boyle and Reis 1987, Goding 1978, Langone 1982). The advantage of using protein A or protein G is their ability to bind to antibodies of many different species (Table 4.6). This is often desirable for laboratories using antibody probes from many different species or using one of the less common primary antibody systems in their experiments; that is, rat, goat, or guinea pig. In addition, these reagents only bind to antibody molecules; this can reduce the background from nonspecific binding of antibodies to membrane-bound proteins when a low-titer, poorly purified second antibody is used. The major limitation of protein A and protein G conjugates is their

**Table 4.6. Immunoglobulin-binding specificities of protein A and protein G.**

Immunoglobulin	Protein A	Protein G	Immunoglobulin	Protein A	Protein G
Human IgG <sub>1</sub>	●●	●●	Pig IgG	●	●●
Human IgG <sub>2</sub>	●●	●●	Rabbit IgG	●●	●●
Human IgG <sub>3</sub>	—	●●	Bovine IgG <sub>1</sub>	—	●●
Human IgG <sub>4</sub>	●●	●●	Bovine IgG <sub>2</sub>	●●	●●
Mouse IgG <sub>1</sub>	●	●	Sheep IgG <sub>1</sub>	—	●●
Mouse IgG <sub>2a</sub>	●●	●●	Sheep IgG <sub>2</sub>	●	●●
Mouse IgG <sub>2b</sub>	●●	●●	Goat IgG <sub>1</sub>	●	●●
Mouse IgG <sub>3</sub>	●●	●●	Goat IgG <sub>2</sub>	●●	●●
Rat IgG <sub>1</sub>	●	●	Horse IgG <sub>(ab)</sub>	●	●●
Rat IgG <sub>2a</sub>	—	●●	Horse IgG <sub>(c)</sub>	●	●●
Rat IgG <sub>2b</sub>	●●	●	Horse IgG <sub>(l)</sub>	—	●
Rat IgG <sub>2c</sub>	●●	●●	Dog IgG	●●	●

●● = Strong binding    ● = Weak binding    — = No binding



lower sensitivity. Because only one ligand molecule binds to each antibody, the enhancement of a multiple-binding detection system, such as a species-specific polyclonal antibody, is lost. Generally, the species-specific antibody is 10–50 times more sensitive than the ligand reagent when the same detection system is used.

## Washes

Between the two antibody incubations and prior to detection, the blot must be washed to remove excess antibody to prevent nonspecific binding. Though the washing solutions and times may vary, depending on the antibodies and detection systems used, washes generally utilize tris-buffered saline (TBS) or TBS with additional detergent (Tween 20; TTBS). Note that the addition of detergent may inhibit certain detection reactions — see the instruction manuals for details. Wash buffer formulations are described in the Appendix of this manual.

## Detection Methods

Blotted proteins are generally detected using secondary antibodies that are labeled with radioisotopes or colloidal gold, or conjugated to fluorophores, biotin, or an enzyme like HRP or AP. Early blotting systems used  $^{125}\text{I}$ -labeled reagents similar to those used in radioimmunoassay. These systems provide sensitive results, but the special handling and disposal problems of  $^{125}\text{I}$  reagents have discouraged continued use of this technique. Instead, a number of enzyme systems and detection reagents evolved (Figure 4.9 and Table 4.7).

By far, the most commonly used detection methods use secondary antibodies conjugated to HRP or AP. With these systems, when the enzyme substrate is added, either a colored precipitate is deposited on the blot (colorimetric detection) or a chemiluminescent or fluorescent product is formed (chemiluminescent and chemi-fluorescent detection) and the light signal is captured on film or with a CCD or fluorescence imager.

### Colorimetric Detection

Enzymes such as AP and HRP convert several substrates to a colored precipitate. As the precipitate accumulates on the blot, a colored signal develops that is visible on the blot (Figure 4.9A). The enzyme reaction can be monitored and stopped when the desired signal over background is produced. Colorimetric detection is easier to use than any film-based detection method, which must be developed by trial and error, and uses costly materials such as X-ray film and darkroom chemicals.

Colorimetric detection is typically considered a medium-sensitivity method, compared to radioactive or chemiluminescent detection.

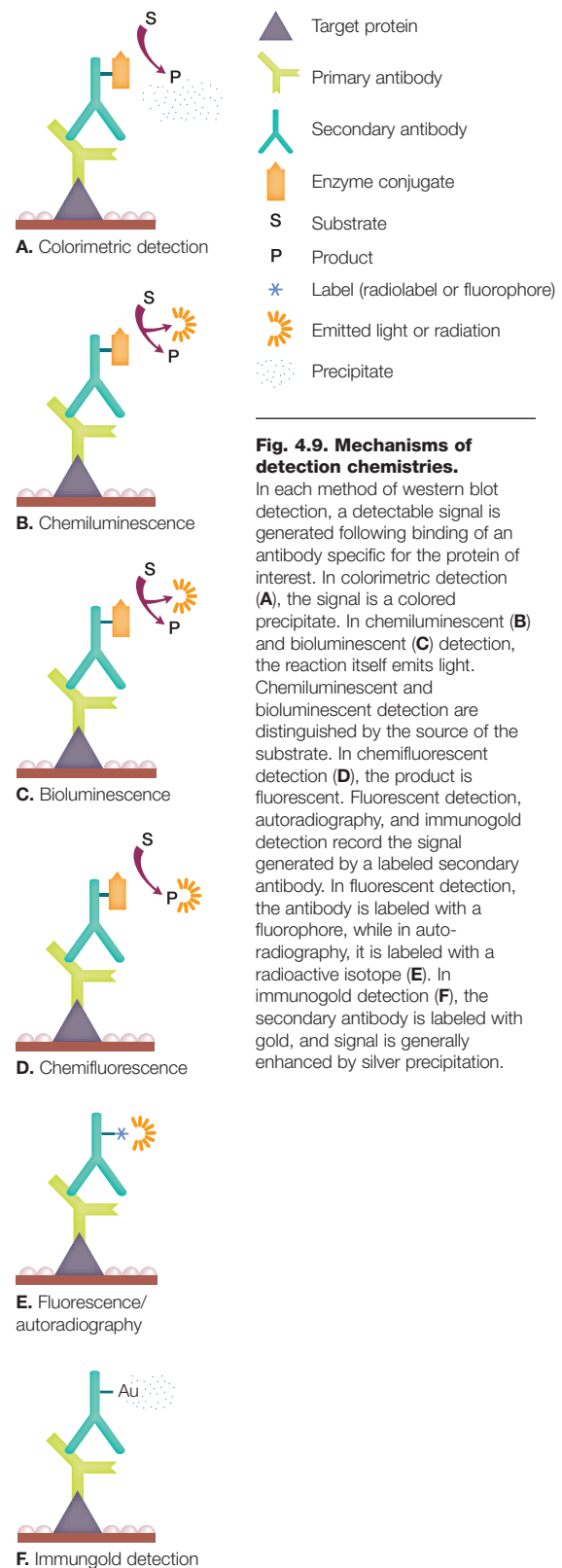

**Table 4.7. Comparison of detection reagent systems.**

	HRP	AP
Sensitivity	500 pg (4CN and DAB) 1–3 pg (Immun-Star™ HRP)	100 pg (Immun-Blot®) 10 pg (Immun-Star AP) 10 pg (Immun-Blot amplified AP)
Substrates	4CN — purple DAB — brown Luminol — emits light	BCIP/NBT — purple CDP-Star — emits light
Comparative cost	Least expensive	More expensive
Stability of stored blots	Poor for 4CN and DAB Good for Immun-Star kits	Good
Restrictions	Azide inhibits peroxidase activity	Endogenous phosphatase activity also detected

However, Bio-Rad has colorimetric systems that offer very high sensitivity equal to detection by chemiluminescence (Table 4.8).

#### Colorimetric HRP Systems

Colorimetric HRP systems were the first enzyme-conjugates used for immunological detection of blotted proteins. The advantage of HRP systems was that both the enzyme conjugate and colorimetric detection substrates were economical. The most common color substrates for HRP are 4-chloro-1-naphthol (4CN) (Hawkes et al. 1982) and 3,3'-diaminobenzidine (DAB) (Tsang et al. 1985) (Figure 4.10). HRP colorimetric detection systems are not as

sensitive as AP colorimetric detection systems. Fading of blots upon exposure to light, inhibition of HRP activity by azide, and nonspecific color precipitation are additional limitations of HRP colorimetric detection systems.

#### Opti-4CN Substrate and Detection Kits

Colorimetric HRP detection with 4CN presents very low background and a detection sensitivity of about 500 pg of antigen. Bio-Rad's Opti-4CN kit improves this detection sensitivity to 100 pg. Opti-4CN is available as a premixed substrate kit or combined with an HRP-conjugated antibody in a detection kit.

**Table 4.8. Colorimetric detection systems.**

Detection Method	Substrate	Detection Sensitivity	Signal Color	Product Options	Advantages	Disadvantages
Colorimetric HRP	4CN	500 pg	Purple	• Dry powder, liquid substrate, Immun-Blot kits	• Fast color development, low cost, low background	• Results fade over time; azide inhibits enzyme activity
	DAB	500 pg	Brown	• Dry powder	• Fast color development, low background	• More safety precautions than for other substrates
	Opti-4CN	100 pg	Purple	• Liquid substrate, Opti-4CN kit	• High sensitivity, nonfading color, low background	• Azide inhibits enzyme activity
	Amplified Opti-4CN	5 pg	Purple	• Amplified Opti-4CN kit	• Best sensitivity available; no extra materials (such as X-ray film) needed	• More expensive than 4CN
Colorimetric AP	BCIP/NBT	100 pg	Purple	• Dry powder, liquid substrate, Immun-Blot kits	• Stable storage of data	• Detects endogenous phosphatase activity
	Amplified BCIP/NBT	10 pg	Purple	• Amplified AP Immun-Blot kit	• High sensitivity	• More steps than unamplified protocol

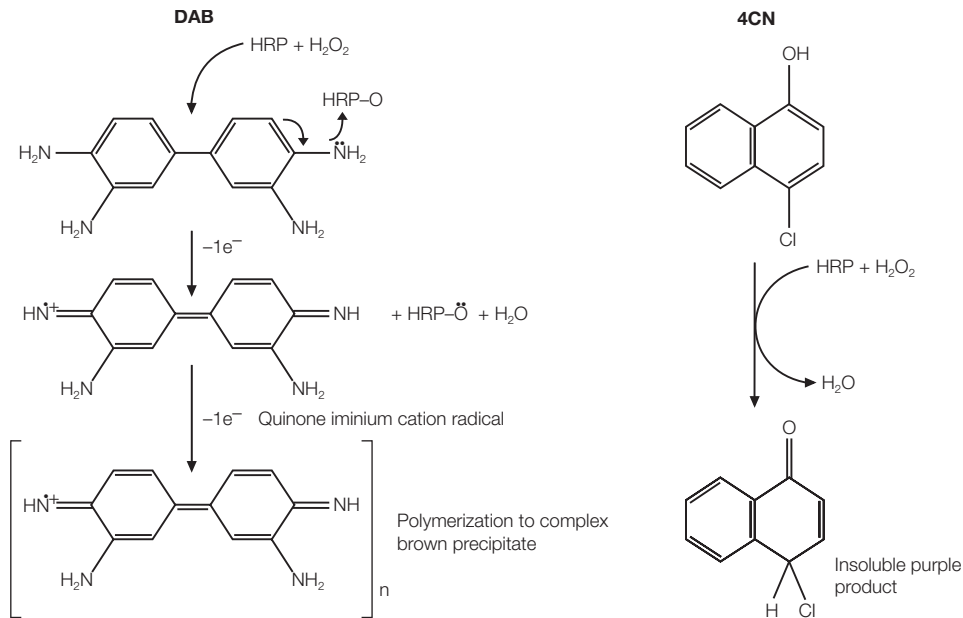

**Fig. 4.10. Colorimetric detection options with HRP.**

DAB and 4CN are commonly used chromogenic substrates for HRP. In the presence of H<sub>2</sub>O<sub>2</sub>, HRP catalyzes the oxidation of the substrate into a product that is visible on a blot. Left, reaction with DAB; right, reaction with 4CN.

#### Amplified Opti-4CN Substrate and Detection Kits

Amplified Opti-4CN substrate and detection kits are based on proprietary HRP-activated amplification reagents from Bio-Rad. These kits allow colorimetric detection to 5 pg, which is comparable to or even exceeds the sensitivity that is achieved with radiometric or chemiluminescence systems, without the cost or time involved in darkroom development of blots.

#### Immun-Blot HRP Assay Kits

Immun-Blot assay kits provide the reagents required to perform standard HRP/4CN colorimetric detection on western blots with the added convenience of premixed buffers and enzyme substrates.

#### Premixed and Individual HRP Colorimetric Substrates

Premixed enzyme substrate kits and development reagents, including powdered 4CN and DAB color development reagents, are also available. The premixed kits are convenient and reliable and reduce exposure to hazardous reagents used in the color development of protein blots.

### Colorimetric AP Systems

Colorimetric AP systems use soluble 5-bromo-4-chloro-3-indolyl phosphate (BCIP) and Nitroblue Tetrazolium (NBT) as substrates to produce a stable reaction product that will not fade (Figure 4.11). AP can be easily inactivated by exposure to acidic solutions. Multiple probing of the same membrane with alternative antibody probes is easily performed using substrates that produce different colors, such as blue and red (Blake et al. 1984, Turner 1983).

**Fig. 4.11. AP colorimetric development.** In the colorimetric system, AP catalyzes the substrates BCIP and NBT to produce a colored precipitate visualizing the protein on a western blot. First the dephosphorylation of BCIP by AP occurs, yielding a bromochloro indoxyl intermediate. The indoxyl is then oxidized by NBT to produce an indigoid dye (purple precipitate). The NBT is also reduced by the indoxyl, opening the tetrazole ring to produce an insoluble diformazan (blue precipitate). The combination of the indigoid dye of the BCIP and the insoluble formazan of the NBT forms a purple-blue colored precipitate.

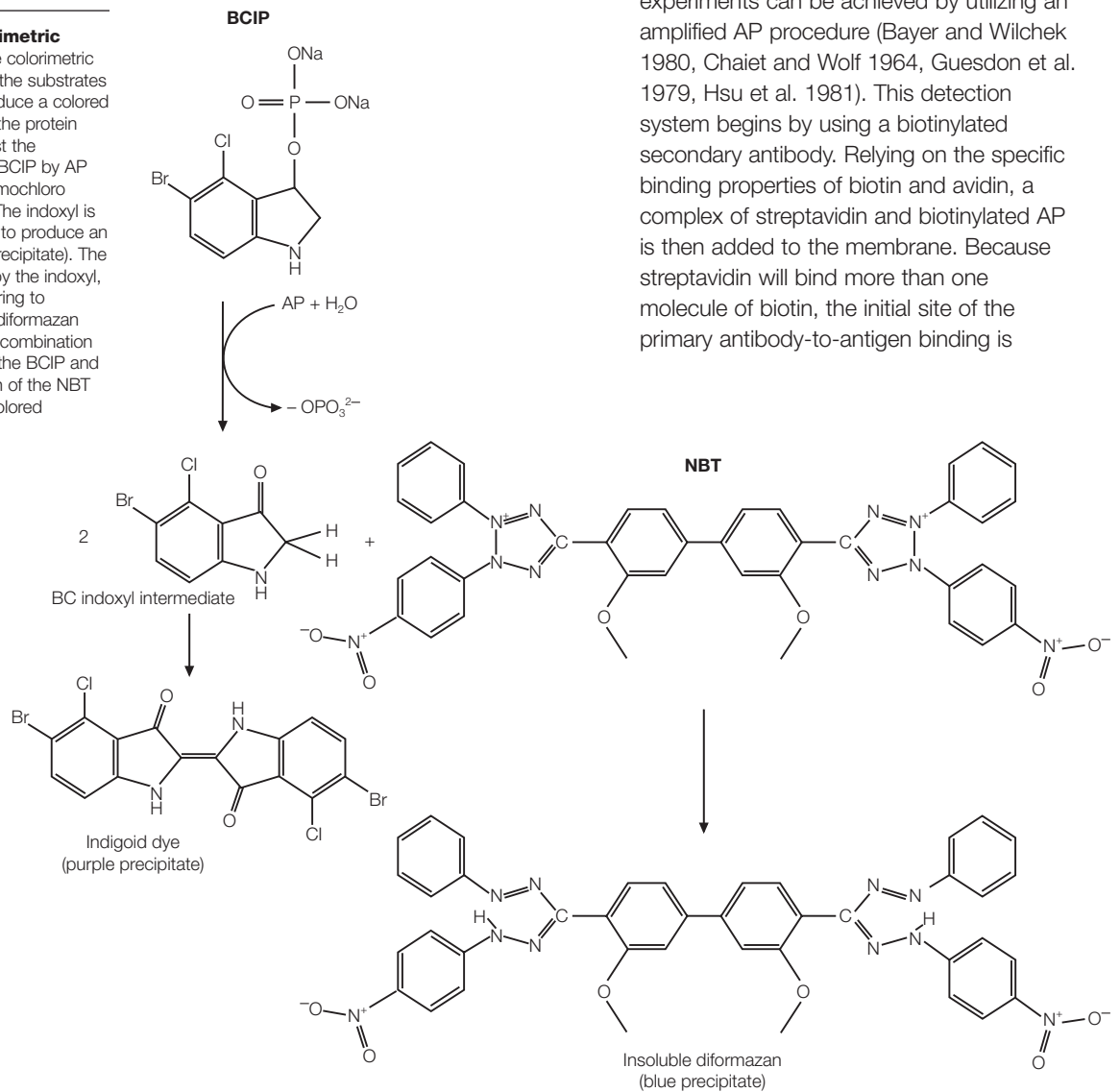

### Immun-Blot AP Assay Kits

The Immun-Blot AP assay kits provide the essential reagents to perform colorimetric detection on western blots with the added convenience of premixed buffers and enzyme substrates. All kit components are individually quality-control tested in blotting applications. Included in each kit is an instruction manual with a thoroughly tested protocol and troubleshooting guide that simplifies immunological detection.

### Immun-Blot Amplified AP Kit

Increased sensitivity in western blot experiments can be achieved by utilizing an amplified AP procedure (Bayer and Wilchek 1980, Chaiet and Wolf 1964, Guesdon et al. 1979, Hsu et al. 1981). This detection system begins by using a biotinylated secondary antibody. Relying on the specific binding properties of biotin and avidin, a complex of streptavidin and biotinylated AP is then added to the membrane. Because streptavidin will bind more than one molecule of biotin, the initial site of the primary antibody-to-antigen binding is

effectively converted into multiple AP binding sites available for color development (Figure 4.12). Color development is performed using conventional AP substrates, as discussed previously. The Immun-Blot amplified AP kit increases the detection sensitivity of colorimetric western blotting to  $\geq 10$  pg of protein.

**Premixed and Individual AP Colorimetric Substrates**

Premixed enzyme substrate kits are convenient and reliable and reduce exposure to hazardous reagents.

**Chemiluminescent Detection**

Chemiluminescence is a chemical reaction in which a chemical substrate is catalyzed by an enzyme, such as AP or HRP, and produces detectable light as a by-product (Figures 4.9B, 4.13, and 4.14A). The light signal can be captured on X-ray film, or by a charge-coupled device (CCD) imager such as the VersaDoc™ and ChemiDoc™ systems.

This technology is easily adapted to existing western blotting procedures because chemiluminescence uses enzyme-conjugated antibodies for the activation of the light signal. The blocking and wash methods are familiar procedures.

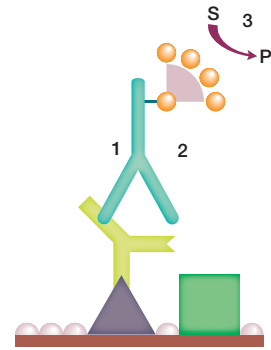

**Fig. 4.12. Immun-Blot amplified AP kit.**

1. Biotinylated secondary antibody binds to primary antibody.
2. Complex of streptavidin and biotinylated-AP binds to biotin of secondary antibody.
3. Multiple APs are available to convert substrate (S) to colored precipitate (P).

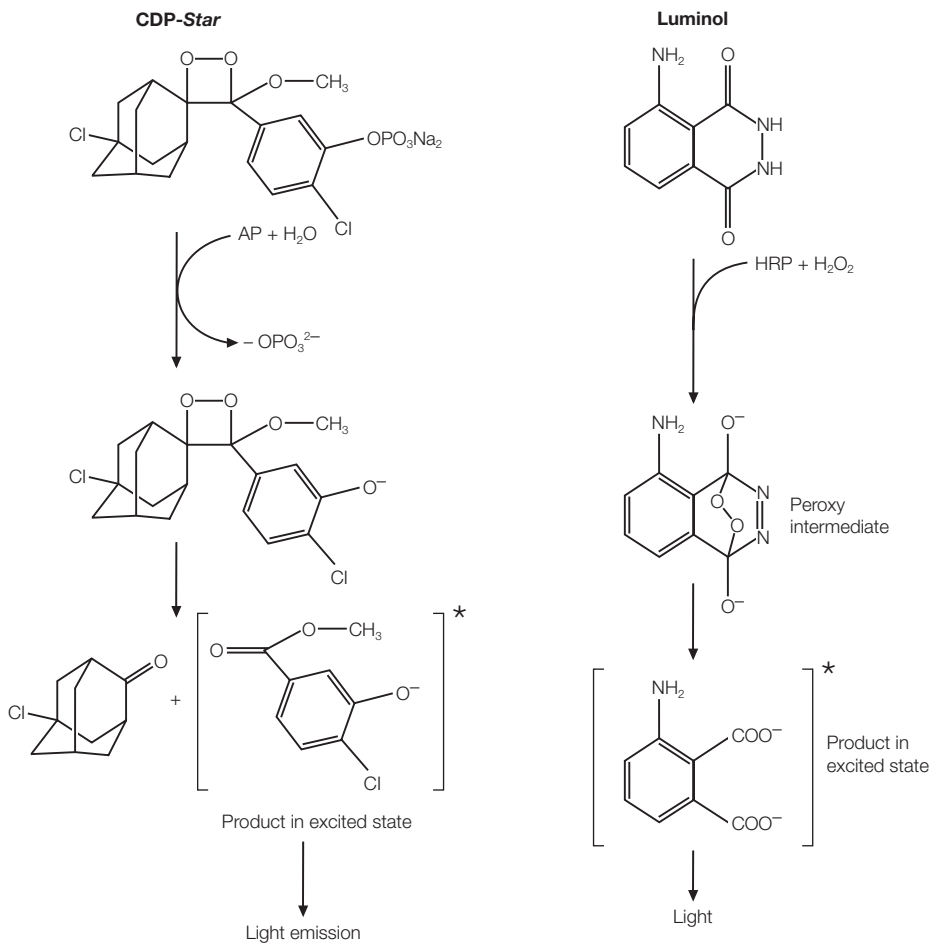

**Fig. 4.13. Chemiluminescent detection.** The secondary antibody is linked to an enzyme, which catalyzes a reaction leading to light emission. Left, CDP-Star or another 1,2-dioxetane AP substrate is dephosphorylated by AP, resulting in formation of an excited-state anion that emits light. Right, luminol oxidized by HRP in the presence of H<sub>2</sub>O<sub>2</sub> leads to formation of a 3-aminophthalate dianion and the release of light.

**Table 4.9. Chemiluminescence detection systems.**

Detection Method	Substrate	Detection Sensitivity	Product Options	Advantages	Disadvantages
Chemiluminescent HRP	Luminol	1–3 pg	<ul style="list-style-type: none"> <li>• Conjugates</li> <li>• HRP substrate</li> <li>• Immun-Blot kits</li> </ul>	<ul style="list-style-type: none"> <li>• Short (30 sec) exposure</li> <li>• Signal duration 6–8 hr</li> <li>• Compatible with PVDF and nitrocellulose</li> <li>• Working solution stable for 24 hr at room temperature</li> </ul>	<ul style="list-style-type: none"> <li>• Azide inhibits enzyme activity</li> </ul>
Chemiluminescent AP	CDP-Star	10 pg	<ul style="list-style-type: none"> <li>• Conjugates</li> <li>• AP substrate</li> <li>• Immun-Blot kits</li> </ul>	<ul style="list-style-type: none"> <li>• 30 sec to 5 min exposure</li> <li>• Signal continues for 24 hr after activation</li> <li>• Blot can be reactivated</li> </ul>	<ul style="list-style-type: none"> <li>• Endogenous phosphatase activity may lead to false positives</li> </ul>

**Fig. 4.14. Detection of CDK7 and Precision Plus Protein™ unstained standards using the Immun-Star HRP chemiluminescent detection kit.**

**A**, proteins and 0.5 µl of standards (lane 1) and a dilution series of a HeLa cell lysate (lanes 2–6) were electrophoresed on a 4–20% Criterion™ gel and transferred to a nitrocellulose membrane. The optimal amount of standards to load on the blot was first determined using a dilution series. The blot was probed with an antibody specific for human CDK7 followed by an HRP-conjugated secondary antibody and StrepTactin-HRP conjugate. After a 2 min incubation in the Immun-Star HRP detection solution, the blot was exposed to film for 5 sec.

**B**, proteins from an identical gel, except with 10 µl of standards, were stained with Bio-Safe™ Coomassie stain (catalog #161-0786) to visualize total protein.

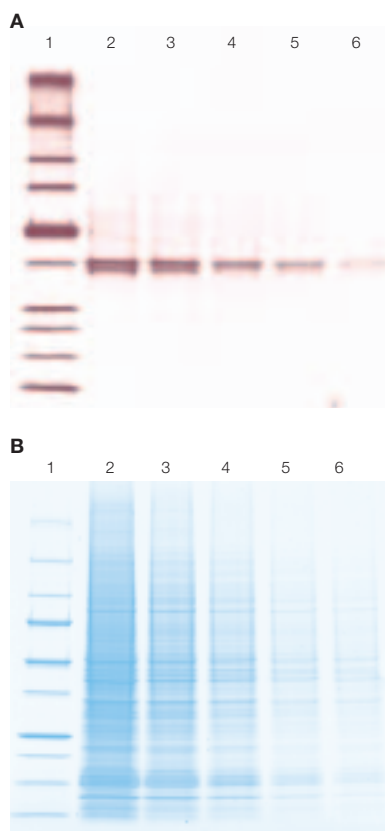

The advantages of chemiluminescent western blotting over other methods are its speed and sensitivity (Table 4.9). This method is perfect for CCD imaging, which avoids the slow film step. Exposure times with average blots are usually 30 sec to 5 min. This is a large improvement over <sup>125</sup>I systems, which can require up to 48 hr for

film exposure. Detection of protein down to low picogram amounts is typical of these systems. This is more sensitive than most colorimetric systems, and approximately equal to radioisotopic detection. The detection sensitivity is dependent on the affinity of the protein, primary antibody, and secondary antibody and can vary from one sample to another.

Safety is another advantage of chemiluminescent detection. It does not have the disadvantages related to isotope detection, such as exposure of personnel to radiation, high disposal costs, and environmental concerns.

#### Immun-Star Chemiluminescent Western Blotting Kits

Immun-Star kits include either CDP-Star substrate, which is activated by AP, or luminol, which is activated by HRP. The Immun-Star kits produce a strong signal on either nitrocellulose or PVDF. The light signal generated with Immun-Star kits not only gives a fast exposure, but also lasts for as long as 24 hr (Immun-Star AP kit) after initial activation of the blot. These blots can also be reactivated with fresh substrate, even weeks after the signal has been depleted (Figure 4.14). They can also be stripped and reprobed multiple times.

### De-Expose™ Background Remover for X-Ray Film

De-Expose background remover allows removal of background from overexposed X-ray film. It can be used for film-based chemiluminescent detection as well as in any application that uses X-ray film exposure. De-Expose background remover can fix background problems regardless of cause, whether overexposure of film, insufficient or incorrect blocking solution, contaminated transfer buffer, impure antibodies, or incorrect antibody or probe dilution. The kit also removes speckles and corrects the intensity of overloaded bands (Figure 4.15).

### Other Detection Methods

#### Bioluminescence

Bioluminescence is the natural phenomenon of light emission by many organisms. Bioluminescent systems differ in the structure and function of enzymes and cofactors involved in the process as well as the mechanism of the light-generating reactions.

Bioluminescence is also used as a detection method for proteins and nucleic acids on a membrane. Bioluminescent detection involves incubation of the membrane (with bound antigen-antibody-enzyme complex) in a bioluminogenic substrate and simultaneous measurement of emitted light (Figure 4.9C). The substrate involved in this detection system is a luciferin-based derivative. Light detection is performed using a photon-counting camera and the blotted proteins are visualized as bright spots.

This technique is similar to chemiluminescence in its sensitivity and speed of detection but it is not widely used and few bioluminogenic substrates are commercially available. PVDF is the preferred membrane for bioluminescent detection because nitrocellulose membranes may contain substances that inhibit luciferase activity.

#### Chemifluorescence

Chemifluorescence is the enzymatic conversion of a substrate to a fluorescent product. Fluorogenic compounds (nonfluorescent or weakly fluorescent substances that can be converted to fluorescent products) are available to use with a wide variety of enzymes, including AP and HRP. The enzyme cleaves a phosphate group from a fluorogenic substrate to yield a highly fluorescent product (Figure 4.9D). The fluorescence can be detected using a fluorescence imager such as the Molecular Imager FX™ Pro Plus system or VersaDoc™ system and quantitated using Quantity One® software. Chemifluorescence can provide a stable fluorescent reaction product, so that blots can be scanned at a convenient time. The method is compatible with standard stripping and reprobing procedures.

#### Fluorescence

In fluorescent detection (Figure 4.9E), the secondary antibody is labeled with a fluorophore such as fluorescein (FITC), Texas Red, rhodamine (TRITC), or R-phycoerythrin. The main advantage of fluorescent detection is that it can provide a 10-fold greater linear dynamic range with only 2- to 4-fold reduced sensitivity over chemiluminescent detection. Fluorescent western blot detection can therefore provide better linearity and better quantitation within the detection limits. Fluorescent detection also allows multiplexing. Multiplexing with different colored fluorophores allows simultaneous detection of several target proteins on the same blot.

#### Autoradiography

The gamma-emitting radioisotope  $^{125}\text{I}$  can be used to label the  $\epsilon\text{-NH}_2$  group of lysines in immunoglobulins for radiometric antigen detection. Direct immunological detection (using labeled secondary antibodies) of as little as 1 pg of dotted immunoglobulin is possible with high specific activity  $^{125}\text{I}$  probes. Radiolabeled blots can be detected using X-ray film, a method known as autoradiography (Figure 4.9E).

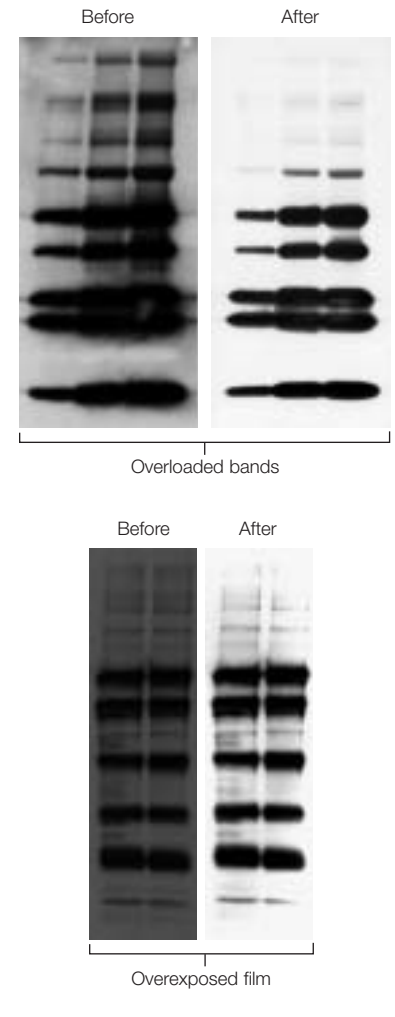

**Figure 4.15. Before and after images demonstrate the effectiveness of De-Expose background remover.**

### Immunogold Labeling

Immunogold detection methods utilize gold-labeled secondary antibodies for antigen detection. Because this method has relatively low sensitivity and the signal is not permanent, silver enhancement methods similar to those described above for colloidal gold total protein stains were developed as a means of enhancing the signal. With silver enhancement, a stable dark brown signal with little background is produced on the blot (Figure 4.9F), and sensitivity is increased 10-fold, equivalent to colorimetric AP detection and several times more sensitive than autoradiography.

### Imaging — Documentation and Analysis Methods

Several methods are employed for the documentation of western blotting results: X-ray film or digital charge-coupled device (CCD) camera imaging for luminescent signals, CCD or laser-based imaging systems for the capture and documentation of fluorescent and colorimetric signals, and X-ray film or phosphor imagers for radiolabeled samples (Table 4.10).

### Luminescent Detection

For chemiluminescent detection methods, CCD imaging is the easiest, most accurate, and rapid method. Traditionally, the chemiluminescent signal from blots has been detected by X-ray film. The popularity of chemiluminescence has led to development of special films with enhanced sensitivity to the blue wavelengths of light emitted by the chemiluminescent substrates. Film is a sensitive medium to capture the chemiluminescent signal but suffers from a sigmoidal response to light that has a narrow linear region, which limits its dynamic range. To gather information from a blot, which has both intense and weak signals, it is necessary to perform multiple exposures to produce data for all samples in the linear range of the film. A process termed preflashing can improve linearity, but this requires extra equipment and effort. Additionally, quantitation of data collected by exposure to film requires digitization (that is, scanning of X-ray film with a densitometer).

**Table 4.10. Comparison of western blot documentation and analysis methods.**

	Film	Densitometry	CCDs	Laser-Based Systems
<b>Exposure Time</b>				
Dynamic range (orders of magnitude)	1.8	3.0	2–4.8	4.8
Linear response throughout dynamic range	No	Yes	Yes	Yes
Cost	Initial investment of processor plus recurring consumable expenses	Initial investment of densitometer	Initial investment of imaging system	Initial investment of imaging system
<b>Detection Method</b>				
Bioluminescent	No	No	Yes	No
Chemiluminescent	Yes	No	Yes	No
Chemifluorescent	No	No	Yes	Yes
Fluorescent	No	No	Yes	Yes
Colorimetric	No	Yes	Yes	Yes
Autoradiography	Yes	No	No	Yes
<b>Detection System</b>	N/A	GS-800™	ChemiDoc XRS or VersaDoc 4000/5000	Molecular Imager FX Pro Plus



A CCD camera is capable of capturing data with a linear response over a broad dynamic range. The linear dynamic range of CCD systems is 2–4.8 orders of magnitude, depending on the bit depth of the system. CCD systems also offer convenience by providing a digital record of experiments for data analysis, sharing, and archiving, and by eliminating the need to continually purchase consumables for film development. Another advantage of the CCD camera is its ability to approach the limit of signal detection in a relatively short time. For example, the VersaDoc 5000 imaging system can reach the limit of detection of a given experiment in less than one minute. For the same experiment, Kodak Bio-Max film requires about 30 min to reach the same limit of detection.

### Fluorescent, Chemifluorescent, and Colorimetric Detection

Fluorescent, chemifluorescent, and colorimetric detection all benefit from the advantages of digital imaging — convenience, digital records of experiments, sensitive limit of detection, and wide dynamic range. Fluorescent and chemifluorescent signals can be detected with a wide range of imaging systems including both CCD and laser-based technologies. For example, the VersaDoc and Molecular Imager FX Pro Plus systems can be used similarly to detect fluorescent and chemifluorescent signals. The decision to use one type of technology over another will depend on budget and requirements for limit of detection and resolution. CCD systems are generally less expensive than laser-based systems. While the dynamic range of CCD imaging systems varies from 2 to 4.8 orders of magnitude, laser-based systems do not provide a choice of dynamic ranges but do provide the widest dynamic range (4.8 orders of magnitude) available. The resolution of CCD and laser-based systems is similar, with the finest resolution settings generally being 50  $\mu\text{m}$  or less.

Another advantage of fluorescent and chemifluorescent detection is that CCD and laser-based detection limits generally far exceed the dynamic ranges of the fluorescent assays currently used for protein detection.

Colorimetric samples can be easily recorded and analyzed with a densitometer such as the GS-800 calibrated densitometer. The densitometer provides a digital record of the blot, excellent resolution, reproducible results, and accurate quantitation. The GS-800 also uses red-, green-, and blue-color CCD technology to greatly improve the detection of a wide range of colorimetric detection reagents.

### Autoradiography

To detect the commonly used radioisotopes,  $^{35}\text{S}$ ,  $^{32}\text{P}$ ,  $^{33}\text{P}$ ,  $^{12}\text{C}$ , and  $^{125}\text{I}$ , the most widely used method is autoradiography on X-ray film. Autoradiography provides a good combination of sensitivity and resolution without a large investment. For direct autoradiography without intensifying screens or scintillators, the response of the film is linear only within a range of 1–2 orders of magnitude. When intensifying screens or fluorographic scintillators are used to increase sensitivity, the response of the film is nonlinear, but it can easily be made linear by preexposing the film to a flash of light. Phosphor imagers, such as Bio-Rad's Molecular Imager FX Pro Plus multiimager, offer an alternative to film detection methods. The initial investment in instrumentation offers increased sensitivity and dynamic range compared to X-ray film, and exposure times are 10 to 20 times shorter than those for film. The ability to accurately quantitate data is also much greater with storage phosphor screens because the linear dynamic range of phosphor imagers is significantly greater, 4.8 orders of magnitude, enabling accurate quantitation and the elimination of overexposure and saturated signals.

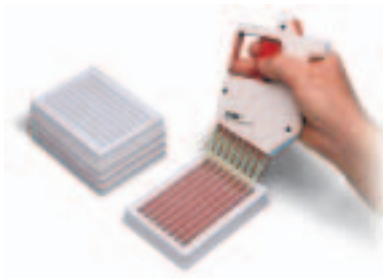

**Fig. 4.16. Mini incubation tray.**

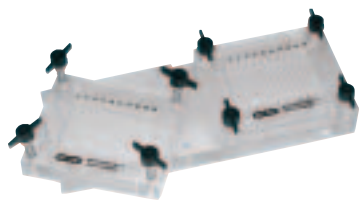

**Fig. 4.17. Multiscreen apparatus.**

**Table 4.11. Multiscreen apparatus specifications.**

Membrane size (W x L)	8 x 7 cm
Number of sample templates	2
Channels per template	20
Sample volume per channel	200–600 $\mu$ l
Dimensions (W x L x H)	27 x 11 x 6 cm

## Screening Apparatus

In some experiments, protein blots need to be screened for a number of different antigens or under a number of different conditions. Mini incubation trays allow screening of individual strips that have been cut from blots. The Mini-PROTEAN® II multiscreen apparatus allows screening of a single blot with up to 40 different antibodies or sera without cutting the blot into individual strips.

### Mini Incubation Trays

Mini incubation trays allow safe, simple, and economical screening of different antigens on protein blot strips. Each tray has eight 10.5 cm x 5 mm channels to accommodate strips cut from a particular protein blot. Because the trays are disposable, the potential contamination associated with washing reusable trays is eliminated. Unique ribs in the tray lids combine with the overall design of the sample channels to ensure that no cross-contamination occurs (Figure 4.16).

### Mini-PROTEAN® II Multiscreen Apparatus

When proteins are resolved by SDS-PAGE and blotted onto a membrane for analysis, the Mini-PROTEAN II multiscreen apparatus simplifies the screening process. Instead of being cut into individual strips for incubation, the entire blot is simply clamped into the multiscreen unit for assay. Two separate, detachable sample templates allow up to 40 different antibody or serum samples to be screened. The unique molded gasket ensures a leakproof seal, preventing cross-contamination between samples (Table 4.11 and Figure 4.17).

# Troubleshooting

## Transfer

### Electrophoretic Transfer ..... 52

- Poor Electrophoretic Transfer
- Swirls or Missing Patterns; Diffuse Transfers
- Gel Cassette Pattern Transferred to Blot
- Poor Binding to the Membrane — Nitrocellulose
- Poor Binding to the Membrane — PVDF

### Blotting Standards ..... 55

- Missing Bands
- Molecular Weight Assignments for Natural (Nonrecombinant) Prestained Standards Differ From Lot to Lot
- A Protein's Molecular Weight Differs From Expected Molecular Weight
- Variation in Mobility Between Recombinant and Natural Prestained Standards of the Same Molecular Weight

### Microfiltration Blotting ..... 56

- Leakage or Cross-Well Contamination
- Uneven Filtration or No Filtration
- Halos Around the Wells

## Detection

### Immunological Detection ..... 57

- Overall High Background
- Nonspecific Reactions Between Bound Proteins and Probes
- No Reaction or Weak Signal
- Tests for Monitoring Reagent Activity

### Multiscreen Apparatus ..... 59

- Leakage or Cross-Well Contamination
- Bubbles Trapped Within the Channels
- Halos Around the Wells

### Total Protein Detection ..... 59

- Colloidal Gold Total Protein Stain — High Background
- Colloidal Gold Total Protein Stain — Low Sensitivity
- Biotin-Blot™ Total Protein Detection — High Background
- Biotin-Blot Total Protein Detection — No Reaction or Weak Color Development
- Anionic Dyes — High Background
- Anionic Dyes — Low Sensitivity

## Transfer

---

### Electrophoretic Transfer

#### Poor Electrophoretic Transfer

1. Transfer time was too short.
  - Increase the transfer time (thicker gels require longer transfer time)
2. Power conditions were inappropriate.
  - Always check the current at the beginning of the run. The current may be too low for a particular voltage setting. If the buffer is prepared improperly, the conductivity may be too low, and not enough power will be delivered to the cell. See the power guidelines for specific applications in Chapter 2
  - Remake the buffer or increase the voltage
  - Try the high-intensity blotting option
  - Make sure the power supply being used has a high current limit. If an incorrect power supply is used, it is possible to not reach the set voltage if the current of the power supply is at its maximum limit
3. Proteins were transferred through the membrane.
  - If the power conditions are set too high, or the transfer run too long, proteins may be transferred through the membrane and into the filter paper. See “Poor Binding to the Membrane” for hints on how to improve binding
4. Proteins moved in the wrong direction.
  - The gel/membrane sandwich may have been assembled in the wrong order or the cassette inserted in the tank in the wrong orientation. Check the polarity of the connections to the power supply
5. The detection system is not working or is not sensitive enough.
  - Include proper positive and negative control antigen lanes to test for kit sensitivity; consult kit manual
  - Stain the gel after transfer with a total protein stain such as Coomassie Blue, Bio-Safe™ Coomassie, or SYPRO Ruby to make sure that proteins have left the gel
6. The charge-to-mass ratio is incorrect (native transfers).
  - Try a more basic or acidic transfer buffer to increase protein mobility. Proteins near their isoelectric points will be transferred poorly (buffer pH should be 2 pH units higher or lower than the pI of the protein of interest for optimal transfer efficiency)
7. Protein precipitated in the gel.
  - Use SDS in the transfer buffer. SDS can increase transfer efficiency, but note that it can also reduce binding efficiency to nitrocellulose and affect reactivity of some proteins with antibodies
  - Reduce or eliminate the amount of alcohol in the transfer buffer
8. Methanol in the transfer buffer is restricting elution.
  - Reducing the amount of methanol results in increased transfer efficiency of proteins from the gel, but it also decreases binding to nitrocellulose membranes; 20% methanol is generally optimal for protein binding
9. The power supply circuit is inoperative, or an inappropriate power supply was used.
  - Check the fuse and make sure the voltage and current output of the power supply match the needs of the blotting instrument
  - Check the output capacity of the power supply

10. The gel percentage was too high.

- Reduce %T (total monomer) or %C (crosslinker). Using 5%C (with bis-acrylamide as the crosslinker) will produce the smallest pore size gel. Decreasing this concentration will increase the pore size and increase transfer efficiency

### Swirls or Missing Patterns; Diffuse Transfers

1. Contact between the membrane and the gel was poor. Air bubbles or excess buffer remain between the blot and gel.
  - Carefully move the roller over the membrane in both directions until air bubbles or excess buffer are removed from between gel and membrane, and complete contact is established
  - Use thicker filter paper in the gel/membrane sandwich
  - Replace the fiber pads. Pads will compress and degrade with time, and will not hold the membrane to the gel
2. Power conditions were inappropriate.
  - Always check the current at the beginning of the run. The current may be too high for a particular voltage setting. If the buffer is prepared improperly, the conductivity may be too high, resulting in excessive power delivered to the cell and overheating. See the power guidelines for specific applications in Chapter 2
3. The membrane was not properly wetted or had dried out.
  - White spots on the nitrocellulose membrane indicate dry areas where protein will not bind. If wetting does not occur immediately by immersion of the sheet in transfer buffer, heat distilled water until just under the boiling point, and soak the membrane until completely wet. Equilibrate in transfer buffer until ready for use
  - Because of the hydrophobic nature of PVDF, the membrane must be prewet in methanol prior to equilibration in aqueous transfer buffer. Follow the directions in the product insert
4. Poor gel electrophoresis.
  - Artifacts of electrophoresis may occur as a result of poor gel polymerization, inappropriate running conditions, contaminated buffers, sample overload, etc. Consult your electrophoresis manual for more details

### Gel Cassette Pattern Transferred to Blot

1. Contaminated or thin fiber pads were used.
  - Replace the fiber pads, or thoroughly clean the contaminated pads
2. Excessive amounts of protein were loaded on the gel, or too much SDS was used in the transfer buffer. Proteins can pass through the membrane without binding, and recirculate through the tank blotting system.
  - Reduce the amount of protein on the gel, and the SDS in the transfer buffer. Add a second sheet of membrane to bind excess protein
3. The transfer buffer was contaminated.
  - Make fresh solutions

### Poor Binding to the Membrane — Nitrocellulose

1. The methanol concentration in the transfer buffer was not optimal.
  - Make sure the buffer contains the proper amount of methanol — 20% is generally optimal for protein binding
2. Proteins passed through the nitrocellulose.
  - Use PVDF or 0.2  $\mu\text{m}$  nitrocellulose (smaller pore size). Decrease the voltage if using the high-intensity option

- Place an additional piece of nitrocellulose membrane in the gel sandwich and analyze this added piece for evidence of proteins that may have been transferred completely through the first piece
- 3. Proteins with molecular weight <15,000 may show decreased binding to 0.45  $\mu$ m nitrocellulose, or may be washed from the membrane during assays.
  - Use PVDF or nylon membrane, which have higher binding capacities
  - Use 0.2  $\mu$ m nitrocellulose
  - Use Tween 20 detergent in the wash and antibody incubation steps. Reduce or eliminate the more stringent washing conditions
- 4. SDS in the transfer buffer reduces the binding efficiency of proteins.
  - Reduce or eliminate the SDS from the transfer buffer
- 5. The membrane was not completely wet.
  - White spots on the membrane indicate dry areas where protein will not bind. If wetting does not occur immediately on immersion of the sheet in transfer buffer, heat distilled water until just under the boiling point, and soak the membrane until it is completely wet. Equilibrate in transfer buffer until ready for use
- 6. Contact between the membrane and the gel was poor. Air bubbles or excess buffer remain between the blot and gel.
  - Carefully move the roller over the membrane in both directions until air bubbles or excess buffer are removed from between gel and membrane, and complete contact is established
  - Use thicker filter paper in the gel/membrane sandwich
  - Replace the fiber pads. Pads will compress and degrade with time, and will not hold the membrane to the gel

#### Poor Binding to the Membrane — PVDF

1. The membrane was not completely wet.
  - Because of the hydrophobic nature of PVDF, the membrane must be completely soaked in methanol prior to equilibration in aqueous transfer buffer. Follow the directions in the product insert
2. The membrane was allowed to dry during handling.
  - A completely wet membrane has a gray, translucent appearance. A membrane that has been allowed to dry will show white spots. Since proteins will not bind to the dry spots, rewet the membrane with methanol and reequilibrate in transfer buffer
3. Proteins passed through the membrane.
  - Decrease the voltage if transferring under high-intensity conditions
  - Place a second piece of PVDF membrane in the gel sandwich and analyze this piece for evidence of proteins that may have been transferred completely through the first membrane
  - Reduce transfer time
4. SDS in the transfer buffer reduces the binding efficiency of proteins.
  - Reduce or eliminate the SDS from the transfer buffer
5. Contact between the membrane and the gel was poor. Air bubbles or excess buffer remain between the blot and gel.
  - Carefully move the roller over the membrane in both directions until air bubbles or excess buffer are removed from between gel and membrane, and complete contact is established
  - Use thicker filter paper in the gel/membrane sandwich
  - Replace the fiber pads. Pads will compress and degrade with time, and will not hold the membrane to the gel

## Blotting Standards

### Missing Bands

1. Transfer was incomplete.
  - See “Poor Electrophoretic Transfer” for suggestions on how to enhance transfer efficiency
2. Gel used can only resolve part of the molecular weight range of the standard used.
  - Use the standard with the appropriate molecular weight range for protein of interest gel concentration
3. Detection was poor using biotinylated standards.
  - See “No Reaction or Weak Signal” for suggestions on how to enhance detection

### Molecular Weight Assignments for Natural (Nonrecombinant) Prestained Standards Differ From Lot to Lot

1. Addition of the dye causes proteins to migrate differently from their true molecular weight, and their apparent molecular weight can vary by as much as 10%.
  - The molecular weights of the standards in each lot of prestained and Kaleidoscope™ standards are calibrated against Bio-Rad's Precision Plus Protein™ unstained standards. The lot-specific molecular weight information is included in every vial to roughly estimate the molecular weight of sample proteins

### A Protein's Molecular Weight Differs From Expected Molecular Weight

1. The protein is posttranslationally modified.
  - Posttranslational modifications of natural proteins, such as the addition of carbohydrate units, phosphorylation, and hydroxylation, will alter both the mass and the mobility of proteins
2. The protein contains an unusual proportion of basic or acidic amino acids.
  - The primary amino acid composition may affect a protein's mobility. A protein with a large number of basic amino acids residues such as lysine, arginine, or histidine (including His tags or patches) will migrate at a higher apparent molecular weight than anticipated, compared to a recombinant protein of the same molecular weight. For instance, lysozyme, a protein containing many lysine residues, will migrate more slowly than other proteins of the same molecular weight. Conversely, proteins with a net negative charge due to the presence of glutamate or aspartate residues will migrate more quickly, resulting in a lower apparent molecular weight
3. Previous estimates of the molecular weight of the protein were made using a different standard.
  - Due to differences in protein composition between standards, the  $r^2$  values for two standards will not be identical. Using different standards to estimate the molecular weight of an unknown protein at different times, or to compare one protein to another, can produce different results. Once an unknown protein is calibrated to a particular protein standard, the same standard should be used for all subsequent molecular weight estimations

### Variation in Mobility Between Recombinant and Natural Prestained Standards of the Same Molecular Weight

1. The amino acid composition of the protein standards is different.
  - Due to differences in protein composition between standards, the  $r^2$  values for two standards will not be identical. Using different standards to estimate the molecular weight of an unknown protein at different times, or to compare one protein to another, will lead to different conclusions. Once an unknown protein is calibrated to a particular protein standard, that standard should be used for molecular weight estimation
  - In order to most accurately determine molecular weight, mass spectrometry should be used to confirm molecular weight estimation by gel analysis. This is a common, high-technology application that gives the precise molecular weight of any protein

### Microfiltration Blotting

#### Leakage or Cross-Well Contamination

1. The instrument was assembled incorrectly.
  - The screws must be retightened under vacuum following initial assembly to form a proper seal
2. The membrane was not rehydrated after assembly.
  - Rehydrate the membrane prior to loading samples. Apply vacuum only until solutions are removed from the sample wells, then disconnect the vacuum

#### Uneven Filtration or No Filtration

1. The membrane became clogged with particulates.
  - Centrifuge samples or filter solutions prior to application to remove particulates
2. The flow valve was positioned higher than the apparatus.
  - The flow valve must be lower than the level of the sample wells or drainage will not occur
3. Bubbles obstructed the flow of liquid.
  - Use a needle to carefully break any bubbles, being careful not to puncture the membrane
  - Pipet liquid up and down to displace the bubbles
4. Improper blocking or antibody buffers were used.
  - Gelatin clogs the membrane; BSA or Tween 20 can be substituted for gelatin in the detection procedure
5. Fluid pressure was not uniform.
  - Seal off unused wells or add solution to unused wells

#### Halos Around the Wells

1. The membrane was not rehydrated after assembly.
  - Rehydrate the membrane prior to loading samples. Apply vacuum only until solutions are removed from the sample wells, then disconnect the vacuum
2. Too much protein was loaded, overloading the capacity of the membrane.
  - Determine optimal loading conditions by performing serial dilutions of samples
3. The blocking step was too short.
  - Make sure blocking step is as long as the longest incubation period
4. Loading volume was too low.
  - The meniscus contacted the center of the well causing uneven distribution of protein sample. The minimum loading volume is 100  $\mu$ l



## Detection

---

### Immunological Detection

#### Overall High Background

1. Blocking was incomplete.
  - Match the blocker to the membrane. For example, PVDF membranes require more extensive blocking, usually with nonfat milk
  - Increase the concentration or blocking time as necessary
  - The blocker must be a pure protein. The blocker may be contaminated with material that binds probes nonspecifically
2. Insufficient wash protocols were used.
  - Increase the number, duration, or stringency of the washes. Include progressively stronger detergents in the washes; for example, SDS is stronger than Nonidet P-40 (NP-40), which is stronger than Tween 20. Also, include Tween 20 in the antibody dilution buffers to reduce nonspecific binding
3. The blot was left in the substrate too long.
  - Remove the blot from the substrate solution when the signal-to-noise level is acceptable. Do not overdevelop. Stop the reaction immediately by immersing the blot in ddH<sub>2</sub>O
4. Contamination occurred during electrophoresis or transfer.
  - Discard and remake the gel and transfer solutions
  - Replace or thoroughly clean contaminated fiber pads if a tank blotter was used
5. Excessive amounts of protein were loaded on the gel, or too much SDS was used in the transfer buffer. Proteins can pass through the membrane without binding and recirculate through a tank blotting system.
  - Reduce the amount of protein on the gel or SDS in the transfer buffer. Add a second sheet of membrane to bind excess protein
6. The primary or secondary antibody was too concentrated.
  - Increase the dilution of the antibodies. Perform a dot-blot experiment to optimize the working concentrations
7. The incubation trays were contaminated.
  - Clean the trays or use disposable trays

#### Nonspecific Reactions Between Bound Proteins and Probes

1. The primary or secondary antibody is contaminated with nonspecific IgG or with IgG cross-reactive between species.
  - Use purified IgG primary antibody fractions and affinity-purified blotting-grade secondary antibody
2. Monoclonal antibodies may have reacted nonspecifically with SDS-denatured proteins.
  - Compare the binding of other monoclonal or polyclonal antibodies
  - Blot native proteins as a comparison
3. Nonspecific interactions are occurring due to ionic associations. For example, avidin, a glycosylated protein, may bind to more acidic proteins on blots.
  - Increase the ionic strength of the incubation buffers. Increase the number, duration, or stringency of the washes. Include progressively stronger detergents in the washes; for example, SDS is stronger than Nonidet P-40 (NP-40), which is stronger than Tween 20. Include Tween 20 in the antibody dilution buffers to reduce nonspecific binding

**No Reaction or Weak Signal**

1. The sample load was insufficient.
  - Increase the amount of protein applied
  - Concentrate the sample prior to loading
  - Use a more sensitive assay system
2. Antigen binding to the membrane was insufficient.
  - Stain the gel after transfer or use prestained or Kaleidoscope standards to assess transfer efficiency. See the previous section for suggestions on improving transfer-related problems
3. Antigen denaturation occurred during electrophoresis or transfer.
  - Antibodies, especially monoclonals, may not recognize denatured antigens
  - Electrophorese and transfer proteins under native conditions. Use the super cooling coil and a refrigerated recirculating bath to transfer heat-sensitive proteins
4. The primary or secondary antibody was inactive or nonsaturating.
  - Store the reagents at recommended conditions. Avoid repeated freeze-thaw cycles, bacterial contamination, and heat inactivation
  - Detergents may affect the binding of some antibodies. Eliminate them from the assay, except for the wash after blocking
  - If the antibody titer is too low, optimize the concentration using a dot-blot experiment
  - Increase the antibody incubation times
5. The enzyme conjugate was inactive or nonsaturating.
  - Test the reagent for activity (see below)
  - Store the reagents at recommended conditions. Avoid repeated freeze-thaw cycles, bacterial contamination, and heat inactivation
  - Sodium azide is a potent inhibitor of horseradish peroxidase. Use thimerosal as a bacteriostat
  - Undistilled water may cause inactivation of the enzyme. Use only distilled, deionized water
  - If the conjugate concentration is too low, optimize using a dot-blot experiment
6. The color development reagent was inactive.
  - Test the reagent for activity (see below) and remake if necessary

**Tests for Monitoring Reagent Activity**

1. Test the activity of the color development solution.
  - Combine 1.0 ml of the color development solution with 10  $\mu$ l of full-strength secondary antibody conjugate. The color reaction should occur immediately. If color fails to develop within a few minutes, the color development solution is inactive. Make up a fresh working solution and repeat the color development assay
2. Test the activity of the conjugate solution.
  - Combine 1.0 ml of the color development solution tested above and 1.0 ml of the 1:3,000 dilution conjugate solution. A light-blue tinge should develop within 15 min.
  - If color fails to develop within 25 min, the conjugate solution is suspect. Repeat the procedure with a freshly prepared dilution of conjugate
3. Test the activity of the first antibody solution.
  - Use an ELISA, RID, Ouchterlony immunodiffusion, or precipitation test to determine reactivity of the antibody with the antigen. If possible, repeat the assay procedure with a more concentrated primary antibody solution

## Multiscreen Apparatus

### Leakage or Cross-Well Contamination

1. The instrument was assembled incorrectly.
  - Tighten the screws using a diagonal crossing pattern to ensure uniform pressure on the membrane surface. Do not overtighten, because this will cause the channels to cut into the membrane
2. The sample template has warped and can no longer provide a proper seal. (Heating the apparatus to >50°C will warp the acrylic plates.)

### Bubbles Trapped Within the Channels

1. Tilt the instrument backwards during sample application to help bubbles rise to the top.
  - Slow and careful delivery of reagent also prevents trapping bubbles inside the channels

### Halos Around the Wells

1. The membrane was not rehydrated after assembly.
  - Rehydrate the membrane prior to loading samples. Apply vacuum only until solutions are removed from the sample wells, then disconnect the vacuum
2. Too much protein was loaded, overloading the capacity of the membrane.
  - Determine optimal loading conditions by performing serial dilutions of samples
3. The blocking step was too short.
  - Make sure blocking step is as long as the longest incubation period

## Total Protein Detection

### Colloidal Gold Total Protein Stain — High Background

1. The blocking step was insufficient or was omitted.
  - Block with 0.3% Tween 20 in TBS, using 3 washes of 20 min each
2. Contamination of the membrane occurred at a previous step; electrophoresis or transfer.
  - Discard and remake the gel and transfer solutions
  - Replace or thoroughly clean contaminated fiber pads if a tank blotter was used
3. Excessive amounts of protein were loaded on the gel, or too much SDS was used in the transfer buffer. Proteins can pass through the membrane without binding and recirculate through a tank blotting system.
  - Reduce the amount of protein on the gel or SDS in the transfer buffer. Add a second sheet of membrane to bind excess protein
4. The colloidal gold stain solution was contaminated.
  - The stain is a reusable reagent. Be sure to use a separate, clean plastic container to store previously used reagent in the refrigerator. Discard any reagent that has a viscous sediment at the bottom of the bottle. If the solution is no longer a dark burgundy but a light blue, the stain has been contaminated with buffer salts. Buffer salts will react with the gold sol causing nonspecific precipitation of the reagent onto the membrane. Discard this solution

### Colloidal Gold Total Protein Stain — Low Sensitivity

1. The incubation time was insufficient.
  - Increase the incubation time for detection of low-level signals. Overnight incubation is possible, although background staining can increase
2. Transfer was incomplete.
  - See “Poor Electrophoretic Transfer” for suggestions on how to enhance transfer efficiency

3. The stain was exhausted, as evidenced by the loss of the dark burgundy color and longer staining times.
  - Discard the reagent
4. Buffer salt contamination has occurred; the solution is light blue instead of dark burgundy.
  - Discard the reagent
5. The sample load was too low for the reagent to detect.
  - Use the gold enhancement kit for detection as sensitive as 10 pg of protein per band

#### **Biotin-Blot™ Total Protein Detection — High Background**

1. The membrane was left in the color development solution too long.
  - Remove the membrane from the color development solution when the signal is apparent and no background has developed. Transfer the blot to distilled water immediately to stop development
2. Excessive amounts of protein were loaded on the gel, or too much SDS was used in the transfer buffer. Proteins can pass through the membrane without binding and recirculate through a tank blotting system.
  - Reduce the amount of protein on the gel or SDS in the transfer buffer. Add a second sheet of membrane to bind excess protein

#### **Biotin-Blot Total Protein Detection — No Reaction or Weak Color Development**

1. Transfer was incomplete.
  - See “Poor Electrophoretic Transfer” for suggestions on how to enhance transfer efficiency
2. The sample load was too low for the reagents to detect.
  - Increase the amount of protein loaded on the gel
3. The NHS-biotin solution was inactive.
  - NHS-biotin hydrolyzes in aqueous solutions. Equilibrate the reagent vial to room temperature before opening to prevent condensation of water inside the container. To prevent contamination, use a sterile syringe to remove reagent
  - Add the NHS-biotin reagent to the borate-Tween solution just prior to use
4. Amine-containing buffer salts competed for the biotinylation reagents.
  - Wash the membrane thoroughly in borate-Tween to remove any residual buffer salts from electrophoresis and transfer
5. The avidin-HRP conjugate was inactive.
  - Follow the reagent activity test procedures to determine whether reagent is inactive
6. The color development solution was inactive.
  - Follow the reagent activity test procedures to determine whether reagent is inactive

#### **Anionic Dyes — High Background**

1. Destaining was insufficient.
  - Increase the number and duration of washes with the destaining solution
2. The dye solution was too concentrated.
  - Remake the solution

#### **Anionic Dyes — Low Sensitivity**

1. Anionic dye stains do not detect protein bands below ~100 ng.
  - Use a more sensitive stain such as the colloidal gold stain or the Biotin-Blot protein detection kit
  - Increase the sample load to achieve a similar staining intensity to that of the anionic dye stains

# Appendices

<b>Transfer Buffer Formulations</b> . . . . .	<b>62</b>
<b>Detection Buffer Formulations</b> . . . . .	<b>63</b>
General Detection Buffers . . . . .	63
Total Protein Staining Buffers and Solutions . . . . .	64
Substrate Buffers and Solutions . . . . .	64
<b>Assay Procedures</b> . . . . .	<b>66</b>
Immun-Blot® Assay . . . . .	66
Total Protein Detection Procedures . . . . .	67
<b>Glossary</b> . . . . .	<b>68</b>
<b>References</b> . . . . .	<b>72</b>
<b>Trademarks and Legal Notices</b> . . . . .	<b>73</b>
<b>Ordering Information</b> . . . . .	<b>74</b>

## Transfer Buffer Formulations

---

The following buffers are recommended for use with all of Bio-Rad's electrophoretic transfer cells. Care should be taken when preparing these buffers because incorrect formulation can result in a current that exceeds the recommended conditions.

**Note:** Do not add acid or base to adjust the pH of the following buffers unless indicated. Addition of acid or base may change the ionic strength and conductivity of the buffer.

Only reagent-grade or electrophoresis-grade chemicals and deionized water should be used when preparing transfer buffers. If needed, methanol should be added last to prevent buffer precipitation problems. The formulas listed provide a total volume of 1 L.

<b>Towbin buffer</b>	25 mM Tris, 192 mM glycine, 20% (v/v) methanol (pH 8.3) Dissolve 3.03 g Tris base and 14.4 g glycine in 500 ml deionized H <sub>2</sub> O; add 200 ml of methanol; adjust volume to 1 L with deionized H <sub>2</sub> O.
	<b>Note:</b> the pH will range from pH 8.1 to 8.5 depending on the quality of the Tris, glycine, methanol, and deionized H <sub>2</sub> O.
<b>Towbin buffer with SDS</b>	25 mM Tris, 192 mM glycine, 20% methanol (v/v), 0.025–0.1% SDS (pH 8.3) Add 2.5 to 10 ml of 10% SDS to 1 L of buffer prepared above.
<b>Bjerrum and Schafer-Nielsen buffer</b>	48 mM Tris, 39 mM glycine, 20% methanol (pH 9.2) Dissolve 5.82 g Tris base and 2.93 g glycine in 500 ml deionized H <sub>2</sub> O; add 200 ml methanol; adjust volume to 1 L with deionized H <sub>2</sub> O.
<b>Bjerrum and Schafer-Nielsen buffer with SDS</b>	48 mM Tris, 39 mM glycine, 20% methanol, 1.3 mM SDS (pH 9.2) Add 0.0375 g SDS (or 3.75 ml of 10% SDS) to 1 L of buffer prepared above.
<b>CAPS buffer</b>	10 mM 3-(cyclohexylamino)-1-propanesulfonic acid, 10% methanol (pH 11.0) Dissolve 2.21 g CAPS in 500 ml deionized H <sub>2</sub> O; add 100 ml methanol; adjust volume to 1 L with deionized H <sub>2</sub> O. Measure the pH; it may need to be adjusted with NaOH.
<b>Dunn carbonate buffer</b>	10 mM NaHCO <sub>3</sub> , 3 mM NaCO <sub>3</sub> , 20% methanol (pH 9.9) Dissolve 0.84 g NaHCO <sub>3</sub> and 0.318 g NaCO <sub>3</sub> (anhydrous) in 500 ml deionized H <sub>2</sub> O; add 200 ml methanol; adjust volume to 1 L with deionized H <sub>2</sub> O.
<b>0.7% Acetic acid</b>	Add 7 ml of glacial acetic acid to 1 L with deionized H <sub>2</sub> O.

# Detection Buffer Formulations

## General Detection Buffers

<b>Tris-buffered saline (TBS)</b>	20 mM Tris-HCl, 500 mM NaCl (pH 7.5) Dissolve 4.84 g Tris base and 58.48 g NaCl in 1.5 L deionized H <sub>2</sub> O; adjust pH to 7.5 with HCl; adjust volume to 2 L with deionized H <sub>2</sub> O.
<b>TTBS wash solution</b>	20 mM Tris-HCl, 500 mM NaCl, 0.05% Tween 20 (pH 7.5) Add 0.5 ml Tween 20 to 1 L TBS.
<b>Wash solution for chemiluminescence</b>	20 mM Tris-HCl, 500 mM NaCl, 0.1% Tween 20 (pH 7.5) Add 1 ml Tween 20 to 1 L TBS.
<b>Citrate-buffered saline (CBS)</b>	20 mM citrate, 500 mM NaCl (pH 5.5) Included in Immun-Blot® protein G kits.
<b>TCBS wash solution</b>	20 mM citrate, 500 mM NaCl, 0.05% Tween 20 (pH 5.5) Add 0.5 ml Tween 20 to 1 L CBS.
<b>Blocking solution</b>	3% gelatin-TBS Add 3.0 g gelatin to 100 ml TBS. Heat to 50°C; stir to dissolve. <b>or</b> 1% BSA-TBS Add 1.0 g BSA to 100 ml TBS; stir to dissolve. <b>or</b> 5% nonfat milk-TBS Add 5.0 g nonfat dry milk to 100 ml TBS; stir to dissolve.  <b>Note:</b> Gelatin will clog the membrane and cut off the vacuum flow of the microfiltration units; an alternative blocking solution and antibody buffer must be used with the Bio-Dot® or Bio-Dot SF apparatus.
<b>Blocking solution for chemiluminescence (general)</b>	2% nonfat milk-TBS Add 0.2 g of nonfat dry milk to 10 ml TBS; stir to dissolve.  <b>Note:</b> This blocker is not recommended for avidin-biotin systems.
<b>Antibody buffer</b>	1% gelatin-TTBS Add 2.0 g gelatin to 200 ml TTBS. Heat to 50°C; stir to dissolve. <b>or</b> 1% BSA-TTBS Add 2.0 g BSA to 200 ml TTBS; stir to dissolve. <b>or</b> 5% nonfat milk-TTBS Add 10.0 g nonfat dry milk to 200 ml TTBS; stir to dissolve.  <b>Note:</b> Gelatin will clog the membrane and cut off the vacuum flow of the microfiltration units; an alternative blocking solution and antibody buffer must be used with the Bio-Dot or Bio-Dot SF apparatus.
<b>Antibody buffer for chemiluminescence (Immun-Star™ AP only)</b>	0.2% nonfat milk-TTBS Add 0.4 g nonfat milk to 200 ml TTBS; stir to dissolve.
<b>Antibody buffer for protein G-HRP</b>	1% gelatin-TCBS Add 1.0 g gelatin to 100 ml TCBS. Heat to 50°C; stir to dissolve.
<b>Primary antibody solution</b>	Dilute the primary antibody to the appropriate titer in 100 ml antibody buffer.
<b>Secondary antibody solution</b>	Dilute the secondary antibody conjugate at 1:3,000 by mixing 33 µl antibody conjugate in 100 ml antibody buffer.
<b>Protein G-HRP conjugate solution</b>	Mix 33 µl protein G conjugate solution in 100 ml 1% gelatin in TCBS.
<b>Streptavidin-biotinylated AP complex</b>	Add 33 µl of streptavidin to 100 ml TTBS. Add 33 µl of biotinylated AP to this solution. Allow the complex to incubate 1–3 hr at room temperature before use.

## Total Protein Staining Buffers and Solutions

### Colloidal Gold

**High-Tween TTBS for colloidal gold total protein stain**

20 mM Tris-HCl, 500 mM NaCl, 0.3% Tween 20 (pH 7.5)  
Add 3 ml Tween 20 to 1 L of TBS.

**Citrate buffer for colloidal gold staining**

0.2 M citrate (pH 3.7)  
Dissolve 27.0 g citric acid and 22.0 g sodium citrate in 1 L deionized H<sub>2</sub>O.  
If the pH of the buffer is above 4.0, remake the solution; do not adjust pH.

**Enhancement solution for colloidal gold staining**

Dissolve 0.85 g hydroquinone in 90 ml citrate buffer.  
Dissolve 0.11 g silver lactate in 10 ml deionized H<sub>2</sub>O. Protect this solution from light.  
Mix the two solutions together.

**Fixing solution for colloidal gold staining**

Add 10 ml fixing solution concentrate to 90 ml deionized H<sub>2</sub>O.

### Other Stains

**Borate-Tween solution (BT) for Biotin-Blot™ detection**

0.05 M Na<sub>2</sub>B<sub>4</sub>O<sub>7</sub>•10 H<sub>2</sub>O, 0.2% Tween 20, pH 9.3  
Dissolve 38.14 g Na<sub>2</sub>B<sub>4</sub>O<sub>7</sub>•10 H<sub>2</sub>O in 1.9 L deionized H<sub>2</sub>O. Add 4 ml Tween 20; adjust volume to 2 L with deionized H<sub>2</sub>O.

**Amido Black staining solution**

For nitrocellulose membrane blots:  
Dissolve 0.5% (w/v) Amido Black in 40% methanol or 25% isopropanol, 10% acetic acid.

For PVDF membrane blots:  
Dissolve 0.1% Amido Black in 40% methanol, 10% acetic acid.

**Amido Black destain solution**

25% isopropyl alcohol, 10% acetic acid  
Mix 650 ml deionized H<sub>2</sub>O, 250 ml isopropyl alcohol, and 100 ml glacial acetic acid.  
**or**  
40% methanol, 10% acetic acid (for PVDF membrane)  
Mix 500 ml deionized H<sub>2</sub>O, 400 ml methanol, and 100 ml glacial acetic acid.

**Coomassie Blue R-250 staining solution**

0.1% Coomassie Blue R-250, 40% methanol, 10% acetic acid  
Dissolve 1 g Coomassie Blue R-250 in 500 ml deionized H<sub>2</sub>O, 400 ml methanol, 100 ml acetic acid.

**Coomassie Blue R-250 destain solution**

40% methanol, 10% acetic acid  
Mix 400 ml methanol, 100 ml acetic acid, and 500 ml H<sub>2</sub>O.

**Ponceau S staining solution**

0.2% Ponceau S and 3% TCA  
Dissolve 2 g Ponceau S with 30 g trichloroacetic acid (TCA) and 30 g sulfosalicylic acid in 80 ml of water.

**Ponceau S destain solution**

1% acetic acid  
Mix 5 ml acetic acid up to 500 ml with water.  
Alternative: wash in PBS.

## Substrate Buffers and Solutions

### HRP Substrate Buffers

**4-(chloro-1-naphthol) substrate solution (4CN)**

Dissolve 60 mg 4CN in 20 ml methanol; protect this solution from light. Mix 600 µl 3% hydrogen peroxide into 100 ml TBS (see above). Mix the two solutions together. Use immediately. Alternatively, use HRP conjugate substrate solution in kit format.

**HRP conjugate substrate solution (kit format)**

Dissolve the contents of the premixed color development buffer in deionized H<sub>2</sub>O to a final volume of 1 L. Add 600 µl color reagent B to 100 ml color development buffer. Add 20 ml HRP color reagent A to this solution. Use immediately.

**Diaminobenzidine (DAB)**

Dissolve 50 mg DAB in 100 ml TBS (see above). Add 100 µl 3% hydrogen peroxide. Use immediately.

### AP Substrate Buffers

**AP color development buffer**

0.1 M Tris, 0.5 mM MgCl<sub>2</sub> (pH 9.5)  
Dissolve 0.233 g MgCl<sub>2</sub>•H<sub>2</sub>O and 12.1 g Tris base in 800 ml deionized H<sub>2</sub>O. Adjust pH to 9.5 with HCl; adjust volume to 1 L with deionized H<sub>2</sub>O.

**5-bromo-4-chloroindolyl phosphate/Nitroblue Tetrazolium (BCIP/NBT)**

Prepare 1.0 ml 70% dimethylformamide (DMF) by mixing 0.7 ml DMF with 0.3 ml deionized H<sub>2</sub>O.  
Dissolve 30 mg NBT in the 70% DMF. Dissolve 15 mg BCIP in 1.0 ml DMF. Add both solutions to 100 ml AP color development buffer (see above). Use immediately. Alternatively, use AP conjugate substrate solution in kit format. Use AP conjugate substrate kit.



**AP conjugate substrate solution  
(kit format)**

Dissolve the contents of the premixed color development buffer in deionized H<sub>2</sub>O to a final volume of 1 L. Add 1.0 ml AP color development reagent A and 1.0 ml AP color development reagent B to 100 ml color development buffer. This solution can be stored overnight, but prompt use is recommended.

**Immun-Star AP substrate solution  
(kit format)**

For nitrocellulose membrane blots:

Add 500 µl of the enhancer reagent to 10 ml of Immun-Star chemiluminescent substrate. This solution can be stored at 4°C for up to one week.

For PVDF membrane blots:

Immun-Star AP generates a very fast light signal on PVDF membrane; therefore, the use of an enhancer is not necessary. Use 10 ml chemiluminescent substrate per 200 cm<sup>2</sup>. The substrate is provided ready to use.

**Immun-Star HRP substrate solution  
(kit format)**

For nitrocellulose and PVDF membrane blots:

A 1:1 mixture of luminol/enhancer to peroxide buffer is recommended.  
(12 ml of solution is sufficient for one 8.5 x 13.5 cm Criterion™ blot.)

## Assay Procedures

---

The following is a generalized protocol for colorimetric immunological detection with the Immun-Blot HRP and AP kits. Notes on how this general procedure is modified for other detection systems are provided below. Consult the instruction manual for the particular assay you are using for complete instructions.

### Immun-Blot Assay

Consult the Immun-Blot assay kit manual for complete instructions.

- 1. Wash** Following transfer or protein application, wash the membrane for 5–10 min in TBS.
- 2. Block** Incubate the membrane for 30 min to 1 hr in blocking solution.
- 3. Wash** Wash the membrane twice in TTBS, 5–10 min per wash.
- 4. Primary antibody** Incubate the membrane for 1–2 hr in the primary antibody solution.
- 5. Wash** Wash the membrane twice in TTBS, 5–10 min per wash.
- 6. Conjugate** Incubate the membrane for 30 min to 2 hr in the enzyme conjugate solution.
- 7. Wash** Wash the membrane twice in TTBS, 5–10 min per wash.
- 8. Final wash** Wash the membrane in TBS to remove the Tween 20 from the membrane surface prior to color development.
- 9. Signal development** Incubate the membrane for 5–30 min, depending on the detection method, in the color development/substrate solution.
- 10. Stop** Immerse the membrane for 10 min in deionized H<sub>2</sub>O to stop color development. Change the water at least once during this time to remove residual color development solution.
- 11. Read, dry, store** Take photographs while the membrane is wet to enhance the color. Dry membrane on filter paper and store between sheets of polyester. See procedural notes for chemiluminescent signal development.

#### Note for Protein G-HRP Detection

Follow steps 1–4 above. For step 5 (wash), use TCBS instead of TTBS and then continue with steps 6–11.

#### Notes for Amplified Opti-4CN Detection

Follow steps 1–8 above. Then:

- Incubate membrane in diluted BAR for 10 min
- Wash the membrane 2–4 times in 20% DMSO/PBST for 5 min each time
- Wash 1–2 times in PBST for 5 min. each time
- Incubate the membrane and diluted streptavidin-HRP for 30 min
- Wash the membrane twice in PBST for 5 min each time

Continue with steps 9–11.

#### Notes for Amplified AP Detection

Follow steps 1–5 above. Then:

- Incubate the membrane for 1–2 hr in biotinylated secondary antibody solution
- While the blot is incubating in the biotinylated antibody solution, prepare the streptavidin-biotinylated AP complex. Allow the complex to form for 1 hr at room temperature
- Wash the membrane twice in TTBS, 5–10 min per wash
- Incubate the membrane for 1–2 hr in the streptavidin complex solution

Continue with steps 7–11.

### Notes for Chemiluminescent Detection

Follow steps 1–8 on previous page, except the wash steps 5 and 7 need to be more thorough. Wash the membrane 6 times for 10 min each with strong agitation and a large volume of buffer to reduce background. Then:

- Incubate the membrane for 3–5 min in the chemiluminescent substrate solution
- Drain excess liquid from the blot and seal the membrane in a bag
- Expose the blot to X-ray film (for example, Kodak XAR or BioMax) or instant photographic film, such as Polaroid Type 667 or 612. Typical exposure times are 30 sec to 5 min. Develop the film according to the manufacturer's instructions. Alternatively, an imager such as the Bio-Rad VersaDoc™ or ChemiDoc™ system can be used.

## Total Protein Detection Procedures

### Amido Black, Coomassie Blue R-250, or Ponceau S

- 1. Stain** Incubate for 1–2 min in the staining solution.
- 2. Destain** Destain in destain solution until the background clears.
- 3. Wash** Rinse in TBS or deionized H<sub>2</sub>O before drying.

### Colloidal Gold Total Protein Stain

Consult the Bio-Rad enhanced colloidal gold total protein detection kit manual for complete instructions.

- 1. Wash** Following transfer or protein application, wash the membrane 3 times for 20 min in high-Tween TBS.
- 2. Water rinse** Rinse for 2 min in deionized H<sub>2</sub>O to remove interfering buffer salts.
- 3. Stain** Incubate in colloidal gold stain. Incubation times will vary with the concentration of protein present on the membrane. Most bands will be visible in 1–2 hr. If increased sensitivity is required, continue the assay using the gold enhancement procedure.

### Biotin-Blot Total Protein Detection Procedure

Consult the Biotin-Blot total protein detection kit manual for complete assay instructions.

- 1. Wash** Following transfer or protein application, wash the membrane 3 times for 10 min in BT solution to remove interfering amine compounds.
- 2. Biotinylation** Place the membrane in a suitable container with 100 ml fresh BT solution. Add 200 µl NHS-biotin. Incubate for 15 min.
- 3. Wash** Wash twice in BT solution for 5 min.
- 4. Wash** Wash twice in TTBS for 5 min.
- 5. Conjugate** Incubate the membrane for 1–2 hr in the avidin-HRP solution.
- 6. Wash** Wash the membrane twice in TTBS, 5–10 min per wash.
- 7. Final wash** Wash the membrane in TBS to remove the Tween 20 from the membrane surface prior to color development.
- 8. Signal development** Incubate the membrane for 5–30 min in an HRP color development/substrate solution.
- 9. Stop** Immerse the membrane for 10 min in deionized H<sub>2</sub>O to stop color development. Change the water at least once during this time to remove residual color development solution.

## Glossary

---

<b>4-Chloro-1-naphthol (4CN)</b>	a color development reagent used with horseradish peroxidase (HRP), which produces an insoluble purple reaction product at the site of an enzyme-antibody complex
<b>5-Bromo-4-chloro-indolyl phosphate (BCIP)</b>	a color development reagent used with alkaline phosphatase (AP), which in the presence of NBT produces an insoluble purple reaction product at the site of the enzyme-antibody complex
<b>Alkaline phosphatase (AP)</b>	an enzyme used as a detection reagent, usually conjugated to a secondary antibody probe
<b>Amido Black 10B</b>	an anionic dye used in the total protein detection of blots
<b>Amplified AP kit</b>	a highly sensitive detection kit that utilizes a streptavidin-biotin system
<b>Anionic dye</b>	a negatively charged compound used as a stain; used in blotting to stain proteins immobilized on membranes such as nitrocellulose or PVDF
<b>Antibody</b>	an immunoglobulin; a protein produced in response to an antigen, which specifically binds the portion of the antigen that initiated its production
<b>Antigen</b>	any molecule that specifically binds with an antibody
<b>Assay</b>	an analysis of the quantity or characteristics of a substance
<b>Avidin</b>	a glycoprotein found in egg white that binds biotin with high specificity
<b>Background</b>	nonspecific signal or noise that can interfere with the interpretation of valid signals
<b>Bio-Dot® apparatus</b>	a microfiltration device, used in the immobilization of proteins in free solution onto a membrane; samples are loaded onto a 96-well template and filtered through the membrane by gravity or vacuum flow
<b>Bio-Dot SF apparatus</b>	a microfiltration device, used in the immobilization of proteins in free solution onto a membrane; sample are loaded onto a 48-slot template and filtered through the membrane by gravity or vacuum flow
<b>Bio-Ice™ unit</b>	a cooling unit used in the Mini Trans-Blot® cell
<b>Biotin</b>	a small molecule that binds specifically to avidin or streptavidin
<b>Biotin-Blot™ kit</b>	a total protein staining kit; utilizes biotinylation of the proteins on a membrane and the subsequent detection by avidin-HRP and 4CN
<b>Biotinylated standards</b>	a mixture of proteins used as molecular weight markers, which have been treated to incorporate a limited number of biotin molecules. Because the relatively small biotin molecule does not appreciably alter the standard proteins' mobility in SDS-PAGE, accurate determination of antigen molecular weights directly on the membrane is possible
<b>Bjerrum and Schafer-Nielsen buffer</b>	a commonly used transfer buffer (48 mM Tris, 39 mM glycine, 20% methanol, pH 9.2)
<b>Blocking reagent</b>	a protein used to saturate unoccupied binding sites on a blot to prevent nonspecific binding of antibody or protein probes to the membrane
<b>Blot</b>	immobilization of proteins or other molecules onto a membrane; or, the membrane that has the molecules adsorbed onto its surface
<b>BLOTTO</b>	a formulation of nonfat milk used to block nonspecific binding of proteins to membranes
<b>CDP-Star</b>	a reagent used in chemiluminescent blot detection with AP conjugated antibodies
<b>ChemiDoc™ systems</b>	CCD camera-based imaging systems for visualization and documentation of fluorescent, chemifluorescent, and colorimetric samples
<b>Chemiluminescence</b>	the emission of light due to a chemical reaction; used in the specific detection of blotted molecules

<b>Colloidal gold</b>	a stabilized sol of gold particles; used as a blot detection reagent when conjugated to antibodies or ligands. It produces a rose-red color on the membrane at the site of deposition
<b>Color development reagent</b>	an enzyme substrate used in blotting to visualize the location of an enzyme-antibody complex
<b>Colorimetric detection</b>	detection of molecules of interest by formation of a colored product
<b>Conjugate</b>	an enzyme-antibody compound used in blotting
<b>Coomassie Blue</b>	an anionic dye used in the total protein staining of gels and blots
<b>Criterion™ blotter</b>	a tank blotting apparatus, made specifically to transfer Criterion gels
<b>Diaminobenzidine (DAB)</b>	a color development reagent used with HRP and other peroxidases, which produces an insoluble brown reaction product at the site of the peroxidase-antibody complex
<b>Dot blot</b>	the direct application of proteins in free solution to a membrane
<b>Dunn buffer</b>	a commonly used transfer buffer (10 mM NaHCO <sub>3</sub> , 3 mM Na <sub>2</sub> CO <sub>3</sub> , 20% methanol, pH 9.9)
<b>Electrophoretic blotting</b>	the use of the driving force of an electric field to move proteins from gels to membranes
<b>Enhanced colloidal gold</b>	a procedure for amplification of detection sensitivity, where silver is deposited onto gold particles on a membrane after colloidal gold staining; the resulting black color increases the visibility of lightly stained positive signals
<b>Enzyme conjugate</b>	an enzyme covalently attached to another protein; in blotting, usually an antibody
<b>Fiber pad</b>	a pad used in the Trans-Blot®, Mini Trans-Blot, and Criterion blotter cassettes that helps hold the gel and membrane sandwich in place
<b>Filter paper</b>	cotton fiber paper used in blotting applications and gel drying
<b>Gelatin</b>	a protein commonly used as a blocking reagent in western blotting procedures
<b>High-intensity transfer</b>	a higher-power option available in the Trans-Blot cell and Criterion blotter, accomplished by moving the electrodes closer together, from 8 cm to 4 cm apart
<b>Horseradish peroxidase (HRP)</b>	an enzyme used in the specific detection of molecules on blots, usually conjugated to a secondary antibody probe
<b>Immunoassay</b>	a test for a substance by its reactivity with an antibody
<b>Immunoblotting</b>	blot detection by antibody binding
<b>Immunodetection</b>	detection of a molecule by its binding to an antibody
<b>Kaleidoscope™ standards</b>	a mixture of molecular weight marker proteins from Bio-Rad that have covalently attached dyes of various colors, which make the bands visible during electrophoresis and transfer; when used to assess the transfer efficiency of proteins onto the membrane, the individually colored bands allow unambiguous identification of the standard proteins
<b>Ligand</b>	a molecule that binds another in a complex
<b>Membrane</b>	an immobilizing support medium used in blotting, generally in the form of a sheet that has high affinity for biological molecules; for example, nitrocellulose or PVDF
<b>Membrane/filter paper sandwiches</b>	blotting membrane and filter paper precut for a specific gel size
<b>Microfiltration blotting</b>	the use of a microfiltration device, such as the Bio-Dot apparatus, to immobilize protein in free solution onto a membrane
<b>Mini Trans-Blot cell</b>	a tank blotting apparatus, made specifically to transfer Ready Gel® and Mini-PROTEAN® gels; part of the modular Mini-PROTEAN line of products

<b>Multiscreen apparatus</b>	an instrument that allows the screening of two blots with up to 40 different antibody samples
<b>Native PAGE</b>	a version of PAGE that retains native protein configuration, performed in absence of SDS and other denaturing agents
<b>NHS-biotin</b>	N-hydroxysuccinimide-biotin, a reagent that biotinylates proteins
<b>Nitroblue Tetrazolium (NBT)</b>	a color development reagent used with AP, which with BCIP produces an insoluble purple reaction product at the site of the AP-antibody complex
<b>Nitrocellulose</b>	a general-purpose blotting membrane
<b>Nonenzymatic probe</b>	a molecule used in blot detection that does not involve an enzyme-catalyzed reaction; for example, a radioactive, chemiluminescent, or colloidal gold-labeled molecule
<b>Nonfat dry milk</b>	a material used in solution as a blocking reagent for western blots
<b>Nonspecific binding</b>	the interaction between bound proteins and probes that is not a result of a specific reaction; results in spurious signals on the membrane
<b>PAGE</b>	polyacrylamide gel electrophoresis, a common method of separating proteins
<b>Polyvinylidene difluoride (PVDF) membrane</b>	a membrane used in protein blotting, which has high chemical resistance, tensile strength, binding, and retentive capacity, making it ideal for use in protein sequencing
<b>PowerPac™ power supplies</b>	Bio-Rad's brand of power supplies
<b>Power supply</b>	an instrument that provides the electric power to drive electrophoresis and electrophoretic blotting experiments
<b>Precision Plus Protein™ standards</b>	recombinant protein standards used in blotting and electrophoretic applications; available in all blue, unstained, dual color, and Kaleidoscope formats
<b>Primary antibody</b>	an antibody that binds a molecule of interest
<b>Prestained standards</b>	a mixture of molecular weight marker proteins that have covalently attached dye molecules, which render the bands visible during electrophoresis and transfer; used to assess the transfer efficiency of proteins onto the membrane
<b>Probe</b>	a molecule used to specifically identify another one
<b>Protein A</b>	a protein derived from <i>Staphylococcus aureus</i> that binds a wide range of immunoglobulins from various species
<b>Protein G</b>	a protein derived from <i>Streptococcus</i> that binds a wide range of immunoglobulins from various species, and has a wider range of binding capabilities than protein A
<b>SDS-PAGE</b>	the separation of molecules by molecular weight in a polyacrylamide gel matrix in the presence of a denaturing detergent, sodium dodecyl sulfate (SDS)
<b>Secondary antibody</b>	an antibody that binds a primary antibody; used to facilitate detection
<b>Semi-dry blotting</b>	the use of a semi-dry blotting apparatus, which consists of two horizontally oriented plate electrodes. The gel and membrane sandwich is positioned between them with buffer-soaked filter paper on either side of the sandwich serving as buffer reservoirs
<b>Signal-to-noise ratio</b>	the relative difference in detection level between the specific and background signals
<b>StrepTactin</b>	a genetically engineered form of streptavidin, used with the Precision Plus Protein unstained standards for detection
<b>Strep-tag sequence</b>	an amino acid sequence that can be used to tag a protein, enabling its detection by StrepTactin binding; this sequence is present in Precision Plus Protein unstained standards
<b>Streptavidin</b>	a protein that binds biotin with high affinity; generally regarded as superior to avidin because it is not glycosylated

<b>Substrate</b>	a substance that is reacted upon by an enzyme; for example, a color development reagent
<b>Super cooling coil</b>	an optional accessory of the Trans-Blot cell, which can be attached to a refrigerated water recirculator to cool the buffer during high-intensity transfers
<b>Supported nitrocellulose</b>	a high-tensile-strength blotting membrane; nitrocellulose that has been cast on an inert high-strength support
<b>Tank blotting</b>	the use of a tank blotting apparatus, which consists of a tank of buffer with vertically oriented platinum wire or plate electrodes; the gel and membrane are held in place between the electrodes by a porous cassette
<b>Total protein stain</b>	a reagent that binds nonspecifically to proteins; used to detect the entire protein pattern on a blot or gel
<b>Towbin buffer</b>	a common protein blotting transfer buffer (25 mM Tris, pH 8.5, 192 mM glycine, 20% methanol)
<b>Trans-Blot® cell</b>	a tank-blotting apparatus for large and mini gels
<b>Trans-Blot® Plus cell</b>	a tank blotting apparatus for very large gels
<b>Trans-Blot SD cell</b>	a semi-dry blotting apparatus for large and mini gels
<b>Transfer</b>	the immobilization of proteins or other molecules onto a membrane by electrophoretic or passive means
<b>Tween 20</b>	a nonionic detergent; used in blot detection procedures as a blocking reagent or added to wash buffers to minimize nonspecific binding and background
<b>VersaDoc™ system</b>	a CCD camera-based imaging system
<b>Western blotting</b>	the immobilization of proteins onto a membrane, and the subsequent detection by protein-specific binding and detection reagents

## References

- Akerstrom B et al., Protein G: a powerful tool for binding and detection of monoclonal and polyclonal antibodies, *J Immunol* 135, 2589–2592 (1985)
- Bayer EA and Wilchek M, The use of the avidin-biotin complex as a tool in molecular biology, *Methods Biochem Anal* 26, 1–45 (1980)
- Beisiegel U, Protein blotting, *Electrophoresis* 7, 1–18 (1986)
- Bers G and Garfin D, Protein and nucleic acid blotting and immunobiochemical detection, *Biotechniques* 3, 276–288 (1985)
- Bjerrum OJ and Schafer-Nielsen C, Buffer systems and transfer parameters for semidry electroblotting with a horizontal apparatus, pp 315–327 in Dunn MJ (ed) *Electrophoresis '86: proceedings of the fifth meeting of the International Electrophoresis Society*, VCH, Weinheim, Germany (1986)
- Blake MS et al., A rapid, sensitive method for detection of alkaline phosphatase-conjugated anti-antibody on Western blots, *Anal Biochem* 136, 175–179 (1984)
- Boyle MDP and Reis KJ, Bacterial Fc receptors, *Biotechnology* 5, 697–703 (1987)
- Burnette WN, "Western blotting": electrophoretic transfer of proteins from sodium dodecyl sulfate-polyacrylamide gels to unmodified nitrocellulose and radiographic detection with antibody and radioiodinated protein A, *Anal Biochem* 112, 195–203 (1981)
- Carr DW and Scott JD, Blotting and band-shifting: techniques for studying protein-protein interactions, *Trends Biochem Sci* 17, 246–249 (1992)
- Chaiet L and Wolf FJ, The properties of streptavidin, a biotin-binding protein produced by *Streptomyces*, *Arch Biochem Biophys* 106, 1–5 (1964)
- Crisp SJ and Dunn MJ, Detection of proteins on protein blots using chemiluminescent systems, *Methods Mol Biol* 32, 233–237 (1994)
- Della-Penna D et al., Biotinylated proteins as molecular weight standards on Western blots, *Anal Biochem* 152, 329–332 (1986)
- Dunn MJ, Detection of proteins on blots using the avidin-biotin system, *Methods Mol Biol* 32, 227–232 (1994)
- Dunn MJ, Detection of total proteins on western blots of 2-D polyacrylamide gels, *Methods Mol Biol* 112, 319–329 (1999)
- Egger D and Bienz K, Protein (western) blotting, *Mol Biotechnol* 1, 289–305 (1994)
- Garfin DE and Bers G, Basic aspects of protein blotting, pp 5–41 in Baldo BA et al. (eds) *Protein Blotting. Methodology, Research and Diagnostic Applications*, Karger, Basel (1989)
- Gershoni JM, Protein blotting: developments and perspectives, *Trends Biochem Sci* 10, 103–106 (1985)
- Gershoni JM, Protein blotting: a tool for the analytical biochemist, pp 141–175 in Chrambach A et al. (eds) *Advances in Electrophoresis*, Vol 1, VCH, Weinheim, Germany (1987)
- Gershoni JM, Protein blotting: a manual, *Methods Biochem Anal* 33, 1–58 (1988)
- Gershoni JM and Palade GE, Protein blotting: principles and applications, *Anal Biochem* 131, 1–15 (1983)
- Gershoni JM et al., Protein blotting in uniform or gradient electric fields, *Anal Biochem* 144, 32–40 (1985)
- Goding JW, Use of staphylococcal protein A as an immunological reagent, *J Immunol Methods* 20, 241–253 (1978)
- Gooderham K, Transfer techniques in protein blotting, *Methods Mol Biol* 1, 165–178 (1984)
- Guesdon J-L et al., The use of avidin-biotin interaction in immunoenzymatic techniques, *J Histochem Cytochem* 27, 1131–1139 (1979)
- Harper DR et al., Protein blotting: ten years on, *J Virol Methods* 30, 25–39 (1990)
- Hawkes R et al., A dot-immunobinding assay for monoclonal and other antibodies, *Anal Biochem* 119, 142–147 (1982)
- Hsu SM et al., Use of avidin-biotin-peroxidase complex (ABC) in immuno-peroxidase techniques: a comparison between ABC and unlabeled antibody (PAP) procedures, *J Histochem Cytochem* 29, 577–580 (1981)
- Kurien BT and Scofield RH, Protein blotting: a review, *J Immunol Methods* 274, 1–15 (2003)
- Kyhse-Andersen J, Electroblotting of multiple gels: a simple apparatus without buffer tank for rapid transfer of proteins from polyacrylamide to nitrocellulose, *J Biochem Biophys Methods* 10, 203–209 (1984)
- Langone JJ, Use of labeled protein A in quantitative immunochemical analysis of antigens and antibodies, *J Immunol Methods* 51, 3–22 (1982)
- Moeremans M et al., The use of colloidal metal particles in protein blotting, *Electrophoresis* 8, 403–409 (1987)
- Reinhart MP and Malamud D, Protein transfer from isoelectric focusing gels: the native blot, *Anal Biochem* 123, 229–235 (1982)
- Rohringer R and Holden DW, Protein blotting: detection of proteins with colloidal gold, and of glycoproteins and lectins with biotin-conjugated and enzyme probes, *Anal Biochem* 144, 118–127 (1985)
- Tovey ER and Baldo BA, Comparison of semi-dry and conventional tank-buffer electrotransfer of proteins from polyacrylamide gels to nitrocellulose membranes, *Electrophoresis* 8, 384–387 (1987)
- Tovey ER and Baldo BA, Characterisation of allergens by protein blotting, *Electrophoresis* 8, 452–463 (1987)



Towbin H et al., Electrophoretic transfer of proteins from polyacrylamide gels to nitrocellulose sheets: procedure and some applications, Proc Natl Acad Sci USA 76, 4350–4354 (1979)

Tsang VC et al., Calibration of prestained protein molecular weight standards for use in the “Western” or enzyme-linked immunoelectrotransfer blot techniques, Anal Biochem 143, 304–307 (1984)

Tsang VC et al., Enzyme-linked immunoelectrotransfer blot (EITB), pp 389–414 in Ngo TT and Lenhoff HM (eds) Enzyme-Mediated Immunoassay, Plenum Press, New York (1985)

Turner BM, The use of alkaline-phosphatase-conjugated second antibody for the visualization of electrophoretically separated proteins recognized by monoclonal antibodies, J Immunol Methods 63, 1–6 (1983)

Wisdom GB, Protein blotting, Methods Mol Biol 32, 207–213 (1994)

## Trademarks and Legal Notices

---

The following trademarks used in this guide are the property of Bio-Rad Laboratories:

Bio-Dot®	De-Expose™	Opti-4CN™	Quantity One®
Bio-Lce™	GS-800™	PowerPac™	Ready Gel®
Bio-Rad®	Immun-Blot®	PowerPac™ Basic	Sequi-Blot™
Bio-Safe™	Immun-Star™	PowerPac™ Universal	Trans-Blot®
Biotin-Blot™	Kaleidoscope™	Precision Plus Protein™	Trans-Blot® Plus
ChemiDoc™	Mini-PROTEAN®	Precision Protein™	VersaDoc™
ChemiDoc™ XRS	Mini Trans-Blot®	PROTEAN®	
Criterion™	Molecular Imager FX™ Pro Plus	PROTEAN® Plus	

Acrobat is a trademark of Adobe Systems Incorporated. BioMax and Kodak are trademarks of Eastman Kodak Co. CDP-*Star* is a trademark of Tropix, Inc. Coomassie is a trademark of BASF Aktiengesellschaft. Nonidet is a trademark of Shell International Petroleum Co. Polaroid is a trademark of Polaroid Corporation. StrepTactin and *Strep*-tag are trademarks of Institut für Bioanalytik GmbH. *Strep*-tag technology for western blot detection is covered by U.S. patent 5,506,121 and by UK patent 2,272,698. StrepTactin is covered by German patent application P 19641876.3. Bio-Rad Laboratories, Inc. is licensed by Institut für Bioanalytik GmbH to sell this product for research use only. SYPRO and Texas Red are trademarks of Molecular Probes, Inc. Bio-Rad Laboratories, Inc. is licensed by Molecular Probes, Inc. to sell SYPRO products for research use only, under US patent 5,616,502. Tween is a trademark of ICI Americas, Inc.

## Ordering Information

### Electrophoretic Transfer Cells

Catalog # Description

#### Trans-Blot Cells and Systems

170-3939	Trans-Blot Cell With Plate Electrodes and Super Cooling Coil, includes 2 gel holder cassettes, buffer tank, lid with power cables, 4 fiber pads, 1 pack precut blot absorbent filter paper
170-3853	Trans-Blot Cell With Plate Electrodes, Super Cooling Coil, and PowerPac HC Power Supply
170-3946	Trans-Blot Cell With Plate Electrodes,* includes 2 gel holder cassettes, buffer tank, lid with power cables, 4 fiber pads, 1 pack precut blot absorbent filter paper
170-3850	Trans-Blot Cell With Plate Electrodes and PowerPac HC Power Supply
170-3910	Trans-Blot Cell With Wire Electrodes, includes 2 gel holder cassettes, buffer tank, lid with power cables, 4 fiber pads, 1 pack precut blot absorbent filter paper
170-3825	Trans-Blot Cell With Wire Electrodes and PowerPac HC Power Supply

#### Trans-Blot Cell Accessories

170-3914	Fiber Pads, 15.5 x 20.5 cm, 6
170-3956	Trans-Blot Thick Blot Paper, 15 x 20 cm, 25 sheets
170-3960	Extra Thick Blot Paper, 15 x 20 cm, 30 sheets
170-3943	Trans-Blot Platinum Anode Plate Electrode
170-3944	Trans-Blot Stainless Steel Cathode Plate Electrode
170-3945	Trans-Blot Plate Electrode Pair, platinum anode and stainless steel cathode
170-3920	Trans-Blot Standard Wire Electrode Card, cathode
170-3921	Trans-Blot Standard Wire Electrode Card, anode
170-3912	Super Cooling Coil,* required for all high-intensity transfers
170-3913	Gel Holder Cassette, includes 2 fiber pads
170-3922	Trans-Blot Cell Buffer Tank
170-3923	Trans-Blot Cell Lid With Cables

#### Trans-Blot Plus Cell and Systems

170-3990	Trans-Blot Plus Cell With Plate Electrodes and Super Cooling Coil, includes 3 gel holder cassettes, buffer tank, lid with power cables, 6 fiber pads, 1 pack blot absorbent filter paper (26.5 x 28 cm, 30 sheets), roller, stirbar
170-3991	Trans-Blot Plus Cell With Plate Electrodes, Super Cooling Coil, and PowerPac HC Power Supply
170-3992	Trans-Blot Plus Cell With Plate Electrodes, Super Cooling Coil, and PowerPac Universal Power Supply

#### Trans-Blot Plus Cell Accessories

170-3994	Trans-Blot Plus Gel/Cassette Assembly Tray
170-3995	Fiber Pads, 27 x 28.5 cm, 2
170-3996	Trans-Blot Plus Filter Paper, 26.5 x 28 cm, 60 sheets
170-3997	Stirbar
170-3998	Trans-Blot Plus Roller, 6" wide
170-3999	Trans-Blot Plus Gel Holder Cassette With Clamps
170-4990	Trans-Blot Plus Super Cooling Coil
170-4991	Trans-Blot Plus Platinum Anode Plate Electrode
170-4992	Trans-Blot Plus Stainless-Steel Cathode Plate Electrode
170-4995	Trans-Blot Plus Cell Buffer Tank
170-4996	Trans-Blot Plus Cell Lid With Cables
170-4997	Gel Holder Cassette Clamps, set of 3

#### Mini Trans-Blot Cell and Systems

170-3930	Mini Trans-Blot Electrophoretic Transfer Cell, includes 2 gel holder cassettes, 4 fiber pads, modular electrode assembly, Bio-Ice cooling unit, lower buffer tank, lid with cables, 1 pack precut blot absorbent filter paper (thick), instructions
170-3935	Mini Trans-Blot Module, without lower buffer tank and lid

170-3989	Mini Trans-Blot Cell and PowerPac Basic Power Supply
170-3836	Mini Trans-Blot Cell and PowerPac HC Power Supply
165-3323	Mini-PROTEAN 3 Cell, Mini Trans-Blot Module, and PowerPac Basic Power Supply
165-3324	Mini-PROTEAN 3 Module, Mini Trans-Blot Module, and PowerPac Basic Power Supply

#### Mini Trans-Blot Cell Accessories

170-3931	Mini Gel Holder Cassette
170-3932	Mini Trans-Blot Filter Paper (Thick), 7.5 x 10 cm, 50 sheets
170-3933	Fiber Pads, 8 x 11 cm, 4
170-3934	Bio-Ice Cooling Unit
800-2105	Central Core Assembly, for Mini Trans-Blot cell

#### Criterion Blotters and Systems

170-4070	Criterion Blotter With Plate Electrodes, includes cell assembled with plate electrodes, lid with cables, 2 Criterion gel holder cassettes, 4 fiber pads, 1 pack precut blot absorbent filter paper, gel/blot assembly tray, roller, sealed ice block, instructions
170-4071	Criterion Blotter With Wire Electrodes, includes cell assembled with wire electrodes, lid with cables, 2 Criterion gel holder cassettes, 4 fiber pads, 1 pack precut blot absorbent filter paper, gel/blot assembly tray, roller, sealed ice block, instructions
165-6024	Criterion Cell/Plate Blot System, includes Criterion cell and Criterion blotter with plate electrodes
165-6025	Criterion Cell/Wire Blot System, includes Criterion cell and Criterion blotter with wire electrodes
170-3872	Criterion Blotter With Plate Electrodes and PowerPac HC Power Supply
170-3874	Criterion Blotter With Wire Electrodes and PowerPac HC Power Supply

#### Criterion Blotter Accessories

170-4076	Optional Criterion Blotter Cooling Coil
170-4080	Criterion Gel Holder Cassette
170-4081	Criterion Blotter Platinum Anode Plate Electrode
170-4082	Criterion Blotter Stainless-Steel Cathode Plate Electrode
170-4083	Criterion Blotter Wire Electrode Card, anode
170-4084	Criterion Blotter Wire Electrode Card, cathode
170-4085	Criterion Blotter Filter Paper, 9.5 x 15.2 cm, 50 sheets
170-4086	Criterion Blotter Fiber Pads, 9.5 x 15.2 cm, 4
170-4087	Sealed Ice Block, 2
170-4089	Criterion Gel/Blot Assembly Tray
165-1279	Roller
170-4077	Criterion Blotter Buffer Tank
170-4079	Criterion Blotter Lid With Cables

#### Trans-Blot SD Semi-Dry Cell and Systems

170-3940	Trans-Blot SD Semi-Dry Electrophoretic Transfer Cell, includes Trans-Blot SD transfer cell, Trans-Blot SD agarose gel support frame, extra thick blot paper, instructions
170-3848	Trans-Blot SD Cell and PowerPac HC Power Supply
170-3849	Trans-Blot SD Cell and PowerPac Universal Power Supply

#### Trans-Blot SD Cell Accessories

170-3947	Cathode Plate, stainless-steel upper electrode
170-3942	Anode Plate, platinum-coated lower electrode
170-3966	Extra Thick Blot Paper, for Mini-PROTEAN 3 or Ready Gel® precast gels, 7 x 8.4 cm, 60 sheets
170-3967	Extra Thick Blot Paper, for Criterion gels, 8 x 13.5 cm, 60 sheets
170-3968	Extra Thick Blot Paper, for PROTEAN® II xi gels, 14 x 16 cm, 30 sheets
170-3969	Extra Thick Blot Paper, for PROTEAN II XL gels, 18 x 18.5 cm, 30 sheets

\* Trans-Blot cells require a super cooling coil for high-intensity transfers; the super cooling coil is recommended for all applications using plate electrodes.

## Microfiltration Apparatus

Catalog #	Description
<b>Bio-Dot Apparatus and Systems</b>	
170-3938	Bio-Dot Microfiltration System, includes Bio-Dot and Bio-Dot SF templates, vacuum manifold base, gasket support plate, gasket
170-6545	Bio-Dot Apparatus, includes Bio-Dot sample template, vacuum manifold base, gasket support plate, gasket
170-6547	Bio-Dot Module, without vacuum manifold base, for conversion of Bio-Dot SF to Bio-Dot apparatus
170-6542	Bio-Dot SF Apparatus, includes Bio-Dot SF sample template, vacuum manifold base, gasket support plate, gasket, filter paper
170-6543	Bio-Dot SF Module, without vacuum manifold base, for conversion of Bio-Dot to Bio-Dot SF apparatus
<b>Bio-Dot System Accessories</b>	
170-6546	Bio-Dot Gaskets, 3
170-6544	Bio-Dot SF Gaskets, 2
162-0161	Bio-Dot/Bio-Dot SF Filter Paper, 11.3 x 7.7 cm, 60 sheets

## Power Supplies

Catalog #	Description
164-5052	PowerPac HC Power Supply
164-5070	PowerPac Universal Power Supply

## Nitrocellulose Membranes

Catalog #	Description
<b>Nitrocellulose Membrane (0.45 <math>\mu</math>m)</b>	
162-0115	Nitrocellulose Membrane, 30 cm x 3.5 m, 1 roll
162-0113	Nitrocellulose Membranes, 20 x 20 cm, 5 sheets
162-0116	Nitrocellulose Membranes, 15 x 15 cm, 10 sheets
162-0114	Nitrocellulose Membranes, 15 x 9.2 cm, 10 sheets
162-0148	Nitrocellulose Membranes, 11.5 x 16 cm, 10 sheets
162-0117	Nitrocellulose Membranes, 9 x 12 cm, 10 sheets
162-0145	Nitrocellulose Membranes, 7 x 8.4 cm, 10 sheets
162-0251	Nitrocellulose Membranes, 26.5 x 28 cm, 10 sheets
162-0234	Nitrocellulose/Filter Paper Sandwiches, 8.5 x 13.5 cm, 20 pack
162-0235	Nitrocellulose/Filter Paper Sandwiches, 8.5 x 13.5 cm, 50 pack
162-0214	Nitrocellulose/Filter Paper Sandwiches, 7 x 8.5 cm, 20 pack
162-0215	Nitrocellulose/Filter Paper Sandwiches, 7 x 8.5 cm, 50 pack
<b>Nitrocellulose Membrane (0.2 <math>\mu</math>m)</b>	
162-0112	Nitrocellulose Membrane, 30 cm x 3.5 m, 1 roll
162-0150	Nitrocellulose Membranes, 20 x 20 cm, 5 sheets
162-0147	Nitrocellulose Membranes, 13.5 x 16.5 cm, 10 sheets
162-0146	Nitrocellulose Membranes, 7 x 8.4 cm, 10 sheets
162-0252	Nitrocellulose Membranes, 26.5 x 28 cm, 10 sheets
162-0232	Nitrocellulose/Filter Paper Sandwiches, 8.5 x 13.5 cm, 20 pack
162-0233	Nitrocellulose/Filter Paper Sandwiches, 8.5 x 13.5 cm, 50 pack
162-0212	Nitrocellulose/Filter Paper Sandwiches, 7 x 8.5 cm, 20 pack
162-0213	Nitrocellulose/Filter Paper Sandwiches, 7 x 8.5 cm, 50 pack

### Supported Nitrocellulose Membrane (0.45 $\mu$ m)

162-0094	Supported Nitrocellulose Membrane, 30 cm x 3 m, 1 roll
162-0093	Supported Nitrocellulose Membranes, 20 x 20 cm, 10 sheets
162-0092	Supported Nitrocellulose Membranes, 15 x 15 cm, 10 sheets
162-0091	Supported Nitrocellulose Membranes, 10 x 15 cm, 10 sheets
162-0090	Supported Nitrocellulose Membranes, 7 x 8.4 cm, 10 sheets
162-0254	Supported Nitrocellulose Membranes, 26.5 x 28 cm, 10 sheets

### Supported Nitrocellulose Membrane (0.2 $\mu$ m)

162-0097	Supported Nitrocellulose Membrane, 30 cm x 3 m, 1 roll
162-0096	Supported Nitrocellulose Membranes, 15 x 15 cm, 10 sheets
162-0095	Supported Nitrocellulose Membranes, 7 x 8.4 cm, 10 sheets
162-0253	Supported Nitrocellulose Membranes, 26.5 x 28 cm, 10 sheets

## PVDF Membranes

Catalog #	Description
<b>Sequi-Blot PVDF Membrane</b>	
162-0184	Sequi-Blot PVDF Membrane, 24 cm x 3.3 m, 1 roll
162-0182	Sequi-Blot PVDF Membranes, 20 x 20 cm, 10 sheets
162-0185	Sequi-Blot PVDF Membranes, 20 x 20 cm, 3 sheets
162-0181	Sequi-Blot PVDF Membranes, 15 x 15 cm, 10 sheets
162-0180	Sequi-Blot PVDF Membranes, 10 x 15 cm, 10 sheets
162-0186	Sequi-Blot PVDF Membranes, 7 x 8.4 cm, 10 sheets
162-0236	Sequi-Blot PVDF/Filter Paper Sandwiches, 8.5 x 13.5 cm, 20 pack
162-0237	Sequi-Blot PVDF/Filter Paper Sandwiches, 8.5 x 13.5 cm, 50 pack
162-0216	Sequi-Blot PVDF/Filter Paper Sandwiches, 7 x 8.5 cm, 20 pack
162-0217	Sequi-Blot PVDF/Filter Paper Sandwiches, 7 x 8.5 cm, 50 pack

### Immun-Blot PVDF Membrane

162-0177	Immun-Blot PVDF Membrane, 26 cm x 3.3 m, 1 roll
162-0176	Immun-Blot PVDF Membranes, 20 x 20 cm, 10 sheets
162-0175	Immun-Blot PVDF Membranes, 10 x 15 cm, 10 sheets
162-0174	Immun-Blot PVDF Membranes, 7 x 8.4 cm, 10 sheets
162-0238	Immun-Blot PVDF/Filter Paper Sandwiches, 8.5 x 13.5 cm, 20 pack
162-0239	Immun-Blot PVDF/Filter Paper Sandwiches, 8.5 x 13.5 cm, 50 pack
162-0218	Immun-Blot PVDF/Filter Paper Sandwiches, 7 x 8.5 cm, 20 pack
162-0219	Immun-Blot PVDF/Filter Paper Sandwiches, 7 x 8.5 cm, 50 pack

## Blotting Membrane/Filter Paper Sandwiches

Catalog #	Description
<b>Ready Gel Membrane/Filter Paper Sandwiches</b>	
162-0212	0.2 $\mu$ m Nitrocellulose/Filter Paper Sandwiches, 7 x 8.5 cm, 20 pack
162-0213	0.2 $\mu$ m Nitrocellulose/Filter Paper Sandwiches, 7 x 8.5 cm, 50 pack
162-0214	0.45 $\mu$ m Nitrocellulose/Filter Paper Sandwiches, 7 x 8.5 cm, 20 pack
162-0215	0.45 $\mu$ m Nitrocellulose/Filter Paper Sandwiches, 7 x 8.5 cm, 50 pack
162-0218	Immun-Blot PVDF/Filter Paper Sandwiches, 7 x 8.5 cm, 20 pack
162-0219	Immun-Blot PVDF/Filter Paper Sandwiches, 7 x 8.5 cm, 50 pack
162-0216	Sequi-Blot PVDF/Filter Paper Sandwiches, 7 x 8.5 cm, 20 pack
162-0217	Sequi-Blot PVDF/Filter Paper Sandwiches, 7 x 8.5 cm, 50 pack

**Criterion Membrane/Filter Paper Sandwiches**

162-0232	0.2 µm Nitrocellulose/Filter Paper Sandwiches, 8.5 x 13.5 cm, 20 pack
162-0233	0.2 µm Nitrocellulose/Filter Paper Sandwiches, 8.5 x 13.5 cm, 50 pack
162-0234	0.45 µm Nitrocellulose/Filter Paper Sandwiches, 8.5 x 13.5 cm, 20 pack
162-0235	0.45 µm Nitrocellulose/Filter Paper Sandwiches, 8.5 x 13.5 cm, 50 pack
162-0238	Immun-Blot PVDF/Filter Paper Sandwiches, 8.5 x 13.5 cm, 20 pack
162-0239	Immun-Blot PVDF/Filter Paper Sandwiches, 8.5 x 13.5 cm, 50 pack
162-0236	Sequi-Blot PVDF/Filter Paper Sandwiches, 8.5 x 13.5 cm, 20 pack
162-0237	Sequi-Blot PVDF/Filter Paper Sandwiches, 8.5 x 13.5 cm, 50 pack

**Blot Absorbent Filter Paper**

Catalog #	Description
170-3932	Mini Trans-Blot Filter Paper (Thick), 7.5 x 10 cm, 50 sheets
170-3966	Extra Thick Blot Paper, for Mini-PROTEAN 3 or Ready Gel precast gels, 7 x 8.4 cm, 60 sheets
170-4085	Criterion Blotter Filter Paper, 9.5 x 15.2 cm, 50 sheets
170-3967	Extra Thick Blot Paper, for Criterion gels, 8 x 13.5 cm, 60 sheets
170-3959	Extra Thick Blot Paper, 15 x 15 cm, 30 sheets
170-3968	Extra Thick Blot Paper, for PROTEAN II xi gels, 14 x 16 cm, 30 sheets
170-3956	Trans-Blot Thick Filter Paper, 15 x 20 cm, 25 sheets
170-3969	Extra Thick Blot Paper, for PROTEAN II XL gels, 18 x 18.5 cm, 30 sheets
170-3960	Extra Thick Blot Paper, 15 x 20 cm, 30 sheets
170-3996	Trans-Blot Plus Filter Paper, 26.5 x 28 cm, 60 sheets
162-0161	Bio-Dot/Bio-Dot SF Filter Paper, 11.3 x 77 cm, 60 sheets

**Buffer Reagents**

Catalog #	Description
-----------	-------------

**Electrophoresis Buffer Reagents**

161-0710	2-Mercaptoethanol, 25 ml
161-0750	Boric Acid, 500 g
161-0751	Boric Acid, 1 kg
161-0707	Citric Acid, 100 g
161-0610	Dithiothreitol (DTT), 1 g
161-0611	DTT, 5 g
163-2101	Tributylphosphine (TBP), 200 mM, 0.6 ml
163-2109	Iodoacetamide, 30 g
161-0728	EDTA, 100 g
161-0729	EDTA, 500 g
161-0717	Glycine, 250 g
161-0718	Glycine, 1 kg
161-0724	Glycine, 2 kg
161-0720	Sucrose, 1 kg
161-0712	Tricine, 100 g
161-0713	Tricine, 500 g
161-0716	Tris, 500 g
161-0719	Tris, 1 kg
161-0730	Urea, 250 g
161-0731	Urea, 1 kg

**Premixed Buffers**

Catalog #	Description
-----------	-------------

**Electrophoresis Buffers**

161-0732	10x Tris/Glycine/SDS, 1 L
161-0772	10x Tris/Glycine/SDS, 5 L cube
161-0734	10x Tris/Glycine, 1 L
161-0771	10x Tris/Glycine, 5 L

**Blot Transfer and Processing Buffers**

161-0778	10x Tris/CAPS, 1 L
161-0774	20x SSC, 1 L
161-0775	20x SSC, 5 L cube
161-0780	10x Phosphate Buffered Saline, 1 L
170-6435	10x Tris Buffered Saline, 1 L

**Detergents/Blocking Reagents**

170-6537	Gelatin, EIA grade, 200 g
170-6404	Blotting-Grade Blocker, nonfat dry milk, 300 g
170-6531	Tween 20, EIA grade, 100 ml
161-0781	10% Tween 20, 1 L
161-0418	SDS Solution, 20% (w/v), 1 L
161-0783	1x Phosphate Buffered Saline With 1% Casein, 1 L
161-0782	1x Tris Buffered Saline With 1% Casein, 1 L

**Blotting Standards**

Catalog #	Description
-----------	-------------

**Unstained Standards**

161-0304	SDS-PAGE Standards, low range, 200 µl
161-0303	SDS-PAGE Standards, high range, 200 µl
161-0317	SDS-PAGE Standards, broad range, 200 µl
161-0326	SDS-PAGE Standards, polypeptide, 200 µl
161-0363	Precision Plus Protein Unstained Standards, 1,000 µl

**Blotting Standards and Conjugates**

161-0306	Biotinylated SDS-PAGE Standards, low range, 250 µl
161-0307	Biotinylated SDS-PAGE Standards Kit, low range, avidin-HRP
161-0308	Biotinylated SDS-PAGE Standards Kit, low range, avidin-AP
161-0311	Biotinylated SDS-PAGE Standards, high range, 250 µl
161-0312	Biotinylated SDS-PAGE Standards Kit, high range, avidin-HRP
161-0313	Biotinylated SDS-PAGE Standards Kit, high range, avidin-AP
161-0319	Biotinylated SDS-PAGE Standards, broad range, 250 µl
161-0321	Biotinylated SDS-PAGE Standards Kit, broad range, avidin-HRP
161-0322	Biotinylated SDS-PAGE Standards Kit, broad range, avidin-AP
161-0380	Precision Protein™ StrepTactin-HRP Conjugate, 300 µl
161-0382	Precision Protein StrepTactin-AP Conjugate, 300 µl

**Prestained Standards**

161-0305	Prestained SDS-PAGE Standards, low range, 500 µl
161-0309	Prestained SDS-PAGE Standards, high range, 500 µl
161-0318	Prestained SDS-PAGE Standards, broad range, 500 µl
161-0324	Kaleidoscope Prestained Standards, broad range, 500 µl
161-0325	Kaleidoscope Polypeptide Standards, 500 µl
161-0373	Precision Plus Protein All Blue Standards, 500 µl
161-0374	Precision Plus Protein Dual Color Standards, 500 µl
161-0375	Precision Plus Protein Kaleidoscope Standards, 500 µl

**Detection Reagents**

Catalog #	Description
-----------	-------------

**Total Protein Stains and Components**

161-0402	Amido Black 10B, 25 g
161-0400	Coomassie Brilliant Blue R-250, 10 g
170-6517	Enhanced Colloidal Gold Total Protein Detection Kit, includes colloidal gold total protein stain, Tris, Tween 20, gold enhancement kit, instructions
170-6512	Biotin-Blot Total Protein Detection Kit, includes NHS-biotin, avidin-HRP, Tween 20, Tris, HRP color development reagent (4CN), instructions
170-3127	SYPRO Ruby Protein Blot Stain, 200 ml

**Immun-Blot AP Colorimetric Assay Kits**

170-6460	Immun-Blot AP Goat Anti-Rabbit IgG (H + L) Assay Kit
170-6461	Immun-Blot AP Goat Anti-Mouse IgG (H + L) Assay Kit
170-6462	Immun-Blot AP Goat Anti-Human IgG (H + L) Assay Kit
170-6412	Immun-Blot Amplified AP Assay Kit

Immun-Blot amplified AP kit includes 0.5 ml biotinylated antibody, 0.5 ml streptavidin, 0.5 ml biotinylated AP, premixed Tris-buffered saline, nonfat milk, Tween 20, and AP conjugate substrate kit. Immun-Blot AP kits include 0.5 ml antibody conjugate, premixed Tris-buffered saline, Tween 20, gelatin, and substrate kit.

**Blotting-Grade AP Conjugates**

170-6533	Avidin-AP, 1 ml
170-3554	Streptavidin-AP, 0.5 ml
170-6518	Goat Anti-Rabbit IgG-AP, 1 ml
170-6520	Goat Anti-Mouse IgG-AP, 1 ml
170-6521	Goat Anti-Human IgG-AP, 1 ml

**Immun-Blot HRP Colorimetric Assay Kits**

170-6463	Immun-Blot HRP Goat Anti-Rabbit IgG (H + L) Assay Kit
170-6464	Immun-Blot HRP Goat Anti-Mouse IgG (H + L) Assay Kit
170-6465	Immun-Blot HRP Goat Anti-Human IgG (H + L) Assay Kit
170-6466	Immun-Blot Protein A Assay Kit
170-6467	Immun-Blot Protein G Assay Kit
170-8235	Opti-4CN Substrate Kit
170-8237	Opti-4CN Goat Anti-Mouse Detection Kit
170-8236	Opti-4CN Goat Anti-Rabbit Detection Kit
170-8238	Amplified Opti-4CN Substrate Kit
170-8240	Amplified Opti-4CN Goat Anti-Mouse Detection Kit
170-8239	Amplified Opti-4CN Goat Anti-Rabbit Detection Kit

Immun-Blot HRP kits include 0.5 ml antibody conjugate, premixed Tris-buffered saline, Tween 20, gelatin, and substrate kit.

**Blotting-Grade HRP Conjugates**

170-6515	Goat Anti-Rabbit IgG-HRP, 2 ml
170-6516	Goat Anti-Mouse IgG-HRP, 2 ml
172-1050	Goat Anti-Human IgG-HRP, 2 ml
170-6522	Protein A-HRP, 1 ml
170-6425	Protein G-HRP, 1 ml
170-6528	Avidin-HRP, 2 ml

**Blotting Substrate Reagents**

170-6431	HRP Conjugate Substrate Kit, contains premixed 4CN and hydrogen peroxide solutions, color development buffer; prepares 1 L of color development solution
170-6432	AP Conjugate Substrate Kit, contains premixed BCIP and NBT solutions, color development buffer; prepares 1 L of color development solution
170-6534	HRP Color Development Reagent, 4CN, 5 g
170-6535	HRP Color Development Reagent, DAB, 5 g
170-6539	AP Color Development Reagent, BCIP, 300 mg
170-6532	AP Color Development Reagent, NBT, 600 mg
170-6401	Biotinylated Goat Anti-Rabbit IgG (H + L), 1 ml
170-6403	Blotting-Grade Biotinylated AP, 1 ml
170-6408	Blotting-Grade Streptavidin, 1 mg
170-6529	NHS-Biotin, 4 ml

**Immun-Star AP Chemiluminescent Assay Kits**

170-5010	Immun-Star AP Goat Anti-Mouse Detection Kit, includes substrate, enhancer, antibody
170-5011	Immun-Star AP Goat Anti-Rabbit Detection Kit, includes substrate, enhancer, antibody
170-5012	Immun-Star AP Substrate Pack, includes substrate, enhancer
170-5013	Immun-Star AP Goat Anti-Mouse Intro Kit, includes complete reagents for 8 mini blots
170-5014	Immun-Star AP Goat Anti-Rabbit Intro Kit, includes complete reagents for 8 mini blots
170-5018	Immun-Star AP Substrate
170-5015	Blotting Reagents Pack, includes TBS, Tween 20, blocker

All items except intro kits cover 2,500 cm<sup>2</sup> membrane. For complete blotting kits, add the blotting reagents pack to the detection kits. The intro kits provide a low-cost trial of the assay.

**Immun-Star HRP Chemiluminescent Assay Kits**

170-5040	Immun-Star HRP Substrate, 500 ml
170-5041	Immun-Star HRP Substrate, 100 ml
170-5042	Immun-Star Goat Anti-Rabbit-HRP Detection Reagents, include substrate, antibody, 500 ml
170-5043	Immun-Star Goat Anti-Mouse-HRP Detection Reagents, include substrate, antibody, 500 ml
170-5045	Immun-Star Goat Anti-Rabbit-HRP Detection Kit, includes complete reagents, 500 ml
170-5044	Immun-Star Goat Anti-Mouse-HRP Detection Kit, includes complete reagents, 500 ml
170-5046	Immun-Star Goat Anti-Rabbit-HRP Conjugate, 2 ml
170-5047	Immun-Star Goat Anti-Mouse-HRP Conjugate, 2 ml

500 ml kits are sufficient for 4,000 cm<sup>2</sup> of membrane; 100 ml kits are sufficient for 800 cm<sup>2</sup> of membrane

**Detection Accessories**

Catalog #	Description
-----------	-------------

**Mini Incubation Trays**

170-3902	Mini Incubation Trays, 20
170-3903	Mini Incubation Trays, 100

**Mini-PROTEAN II Multiscreen Apparatus**

170-4017	Mini-PROTEAN II Multiscreen Apparatus, includes 2 sample templates, 2 gaskets, base plate
170-4018	Multiscreen Gaskets, 2

**Background Remover**

170-5020	De-Expose Background Remover, 250 ml, 10x
----------	---

**Documentation Systems**

Catalog #	Description
-----------	-------------

170-7980	GS-800 Calibrated Densitometer, PC
170-7981	GS-800 Calibrated Densitometer, Mac
170-8070	ChemiDoc XRS System, PC
170-8071	ChemiDoc XRS System, Mac
170-8140	VersaDoc 4000 Imaging System, PC
170-8141	VersaDoc 4000 Imaging System, Mac
170-8050	VersaDoc 5000 Imaging System, PC
170-8151	VersaDoc 5000 Imaging System, Mac
170-7850	Molecular Imager FX Pro Plus Multimag System, PC
170-7851	Molecular Imager FX Pro Plus Multimag System, Mac



**Bio-Rad  
Laboratories, Inc.**

Life Science  
Group

**Web site** [www.bio-rad.com](http://www.bio-rad.com) **USA** (800) 4BIORAD **Australia** 02 9914 2800 **Austria** (01)-877 89 01 **Belgium** 09-385 55 11 **Brazil** 55 21 2527 3454  
**Canada** (905) 712-2771 **China** (86-21) 63052255 **Czech Republic** + 420 2 41 43 05 32 **Denmark** 44 52 10 00 **Finland** 09 804 22 00  
**France** 01 47 95 69 65 **Germany** 089 318 84-0 **Hong Kong** 852-2789-3300 **Hungary** 36 1 455 8800 **India** (91-124)-6398112/113/114, 6450092/93  
**Israel** 03 951 4127 **Italy** 39 02 216091 **Japan** 03-5811-6270 **Korea** 82-2-3473-4460 **Latin America** 305-894-5950 **Mexico** 55-52-00-05-20  
**The Netherlands** 0318-540666 **New Zealand** 64 9 415 2280 **Norway** 23 38 41 30 **Poland** + 48 22 331 99 99 **Portugal** 351-21-472-7700  
**Russia** 7 095 721 1404 **Singapore** 65-6415 3188 **South Africa** 00 27 11 4428508 **Spain** 34 91 590 5200 **Sweden** 08 555 12700  
**Switzerland** 061 717-9555 **Taiwan** (8862) 2578-7189/2578-7241 **United Kingdom** 020 8328 2000